











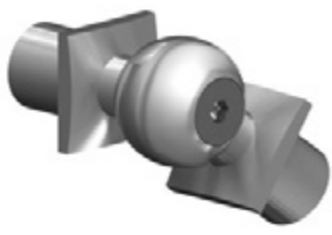
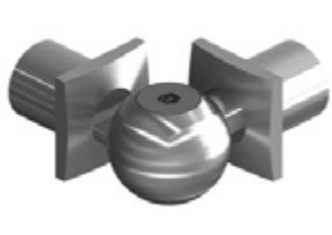







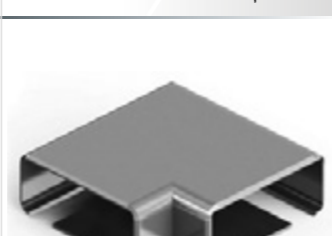

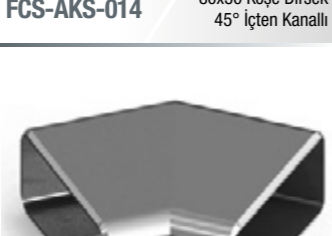





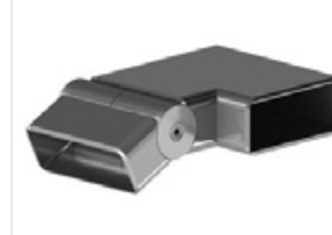

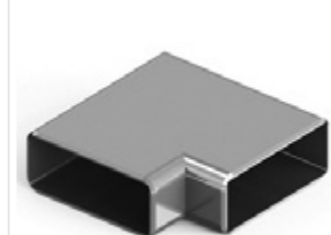
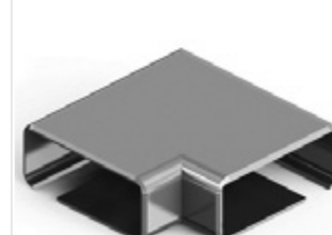
www.focusyapisistemleri.com
info@focusyapisistemleri.com

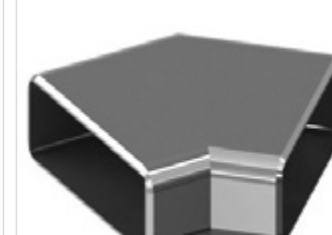



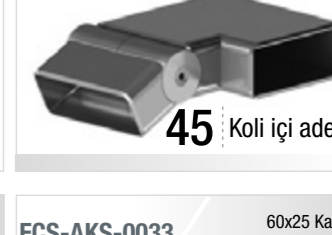



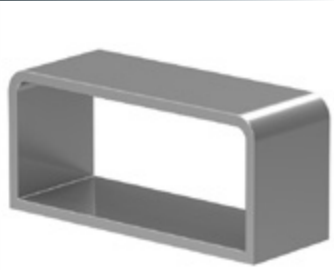
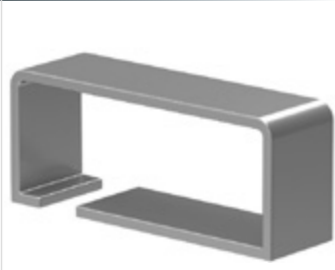
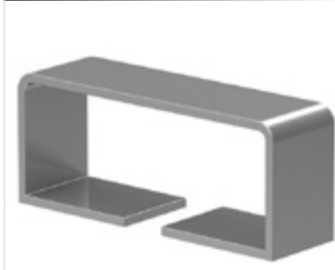
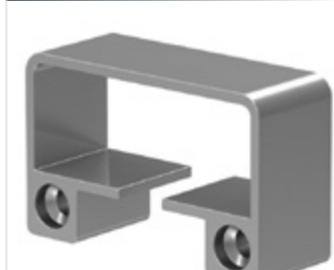
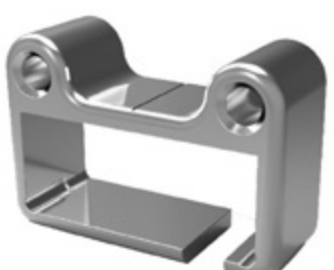

Ürün Grupları

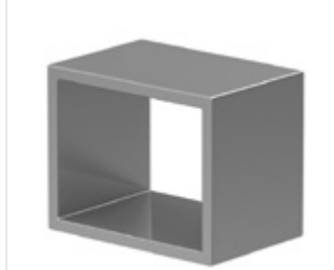
- Alüminyum Kapı Kolları
- Alüminyum Kapı Aksesuarları
- Ankraj ve Bant Grubu
- Matkap Uçlu Vidalar ve Çelik Dübel-ler
- Elektronik Kilitler
- Rulmanlar
- Cam Kapı Kolları Paslanmaz
- Cam Kapı Aksesuarları
- Alüminyum Mafsallar
- Alüminyum Flaşlar
- Alüminyum Tapalar
- Alüminyum Bağlantı Ekipmanları
- Alüminyum Dönüşler
- Alüminyum Bilezikler
- Küpeşte Profilleri
- Silikonlar
- Yapıştırıcılar



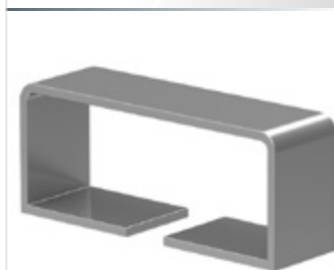
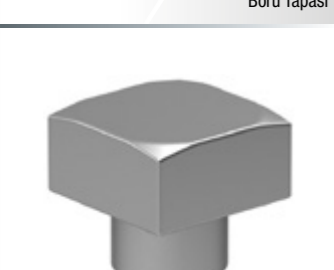













Kare ve
Oval Sistem
Korkuluk
Aksesuarları

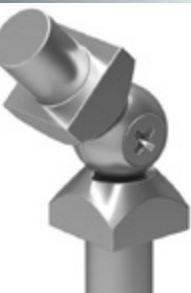







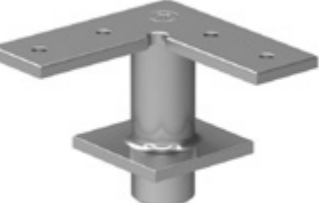

| | | | |
|--|---|--|---|
| FCS-AKS-001 14x14 Topuz Dirsek Dikey | FCS-AKS-002 14x14 Topuz Dirsek Yatay | FCS-AKS-003 40'lık Kare Profil Yandan Bağ. Tk. | FCS-AKS-004 40'lık Kare Ay Mafsallı Takım Yeni |
|  |  |  |  |
| 25 Koli içi adet | 25 Koli içi adet | 100 Koli içi adet | 250 Koli içi adet |
| FCS-AKS-005 40'lık Kare Ay Mafsallı Takım Yeni | FCS-AKS-006 40x40 Kare Yer Flanşı | FCS-AKS-007 40x40 Kare Tapa | FCS-AKS-008 40x40 Kare Emniyet Tapası |
|  |  |  |  |
| 300 Koli içi adet | 400 Koli içi adet | 50 Koli içi adet | 20 Koli içi adet |
| FCS-AKS-009 30x80 Cam Profil Duvar Flanşı | FCS-AKS-010 30x80 Dıştan Delikli Duvar Flanşı | FCS-AKS-011 80x30 Köşe Dirsek 90° Dıştan Kanallı | FCS-AKS-012 80x30 Köşe Dirsek 90° Ortadan Kanallı |
|  |  |  |  |
| 75 Koli içi adet | 130 Koli içi adet | 130 Koli içi adet | 130 Koli içi adet |
| FCS-AKS-013 80x30 Köşe Dirsek 45° Dıştan Kanallı | FCS-AKS-014 80x30 Köşe Dirsek 45° İçten Kanallı | FCS-AKS-015 80x30 Köşe Dirsek Çift Taraflı Hareketli | FCS-AKS-016 80x30 Dirsek Dikey Hareketli |
|  |  |  |  |
| 150 Koli içi adet | 150 Koli içi adet | 25 Koli içi adet | 50 Koli içi adet |

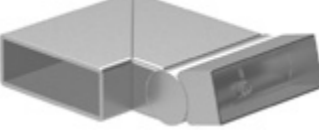

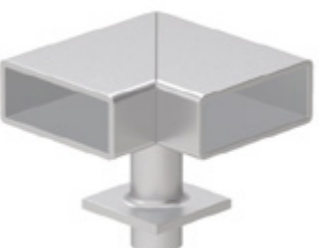
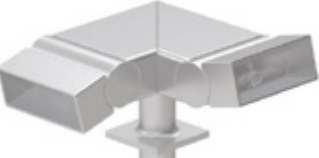



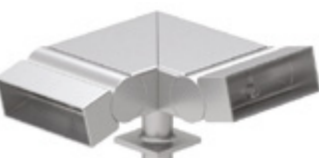
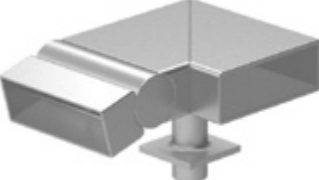
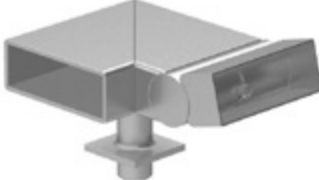
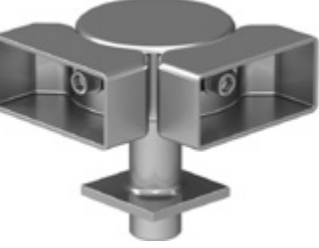
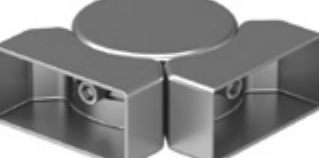

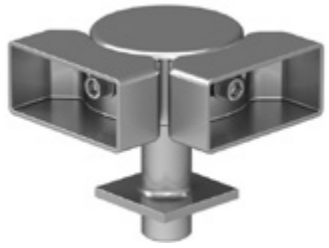
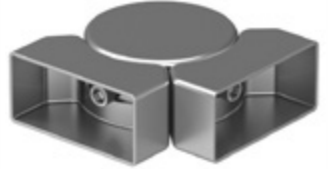
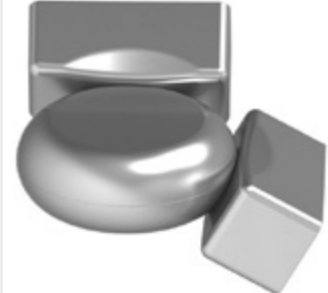
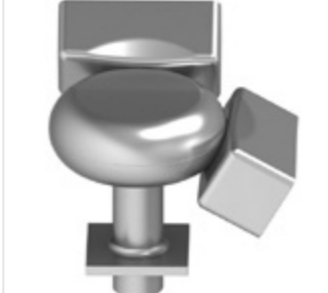
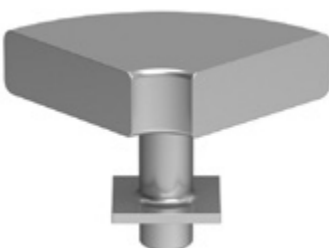
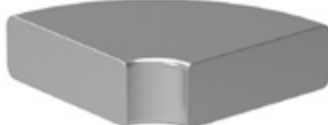
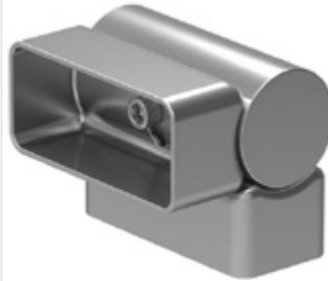

| | | | |
|---|---|---|---|
| FCS-AKS-0017 80x30 Dirsek Yatay Hareketli | FCS-AKS-0018 80x30 Köşe Dirsek Tek Taraflı Hareketli | FCS-AKS-0019 80x30 ve 60x25 Açık Ayarlı Duvar Flanşı (UFO) | FCS-AKS-0020 80x30 Kare Tapa |
|  |  |  |  |
| 40 Koli içi adet | 25 Koli içi adet | 75 Koli içi adet | 300 Koli içi adet |
| FCS-AKS-0021 60x25 Köşe Dirsek 90° | FCS-AKS-0022 60x25 Köşe Dirsek 90° Dıştan Kanallı | FCS-AKS-0023 60x25 Köşe Dirsek 90° Ortadan Kanallı | FCS-AKS-0024 60x25 Köşe Dirsek 45° |
|  |  |  |  |
| 200 Koli içi adet | 200 Koli içi adet | 200 Koli içi adet | 250 Koli içi adet |
| FCS-AKS-0025 60x25 Köşe Dirsek 45° Dıştan Kanallı | FCS-AKS-0026 60x25 Köşe Dirsek 45° Ortadan Kanallı | FCS-AKS-0027 60x25 Dirsek Yatay Hareketli | FCS-AKS-0028 60x25 Köşe Dirsek Çift Taraflı Hareketli |
|  |  |  |  |
| 5 Koli içi adet | 50 Koli içi adet | 50 Koli içi adet | 35 Koli içi adet |
| FCS-AKS-0029 60x25 Köşe Dirsek Tek Taraflı Hareketli | FCS-AKS-0030 60x25 Dirsek Dikey Hareketli | FCS-AKS-0031 60x25 Kare Bilezik | FCS-AKS-0032 60x25 Kare Tapa |
|  |  |  |  |
| 45 Koli içi adet | 45 Koli içi adet | 75 Koli içi adet | 75 Koli içi adet |
| FCS-AKS-0033 60x25 Kare Duvar Flanşı | | | |
|  | | | |
| 300 Koli içi adet | | | |

















| | | | |
|--|---|--|---|
| FCS-AKS-0034 60x25 Bilezik | FCS-AKS-0035 60x25 Önden Kanallı Bilezik | FCS-AKS-0036 60x25 Ortadan Kanallı Bilezik | FCS-AKS-0037 60x25 Ortadan Kanallı D Flanş |
|  |  |  |  |
| 50 Koli içi adet | 50 Koli içi adet | 50 Koli içi adet | 50 Koli içi adet |
| FCS-AKS-0038 60x25 Dıştan Kanallı Vidalı D.Flanş | FCS-AKS-0039 60x25 Duvar Flanş İçten Delikli | FCS-AKS-0040 80x30 Duvar Flanş İçten Delikli | FCS-AKS-0041 35x25 Kare Boru Bileziği |
|  |  |  |  |
| 250 Koli içi adet | 250 Koli içi adet | 75 Koli içi adet | 250 Koli içi adet |
| FCS-AKS-0042 80x30 Tapa Dışa Geçme | FCS-AKS-0043 Köşe Dönüş Takozu | FCS-AKS-0044 80x30 Önden Kanallı Bilezik | FCS-AKS-0045 80x30 Ortadan Kanallı Bilezik |
|  |  |  |  |
| 75 Koli içi adet | 75 Koli içi adet | 75 Koli içi adet | 75 Koli içi adet |
| FCS-AKS-0046 14x14 Kare Boru Tapası | FCS-AKS-0047 25x60 Kare Boru Tapası | FCS-AKS-0048 40x40 Kare Dikme Tapası | FCS-AKS-0049 30x80 Kare Boru Tapası |
|  |  |  |  |
| 50 Koli içi adet | 50 Koli içi adet | 50 Koli içi adet | 100 Koli içi adet |

| | | | |
|---|---|---|---|
| FCS-AKS-0050 25x32 Kare Boru Tapası | FCS-AKS-0051 25x60 Cam Kanallı Profil Tapası | FCS-AKS-0052 30x80 Cam Kanallı Profil Tapası | FCS-AKS-0053 27x20 Profil Tapası |
|  |  |  |  |
| 250 Koli içi adet | 250 Koli içi adet | 75 Koli içi adet | 75 Koli içi adet |
| FCS-AKS-0054 40x40 Kare Dikme Yankılı Tapa | FCS-AKS-0055 Kare Baba Profil | FCS-AKS-0056 30x80 Kanallı Kare Boru Bileziği | FCS-AKS-0057 25x60 Kare Dirsek Takozu |
|  |  |  |  |
| 75 Koli içi adet | 75 Koli içi adet | 50 Koli içi adet | 50 Koli içi adet |
| FCS-AKS-0058 25x60 Kare Boru Bağlantı Takozu | FCS-AKS-0059 32x25 Kare Boru Bağlantı Takozu | FCS-AKS-0060 Kare Dirsek Takozu | FCS-AKS-0061 40x40 Kare Dikme Sabit Mafsal Takımı |
|  |  |  |  |
| 50 Koli içi adet | 50 Koli içi adet | 50 Koli içi adet | 50 Koli içi adet |
| FCS-AKS-0062 40x40 Kare Dike 50'lik Boru Mafsal Takımı | FCS-AKS-0063 40'lık Dikme Kare Profil Sabit Mafsal | FCS-AKS-0064 40x40 Kare Dikme Sabit Mafsal | FCS-AKS-0065 40x40 Kare Dikme Mafsal T Bağlantı |
|  |  |  |  |
| 50 Koli içi adet | 50 Koli içi adet | 50 Koli içi adet | 50 Koli içi adet |

| | | | |
|---|---|--|---|
| FCS-AKS-0066 70x70 Kare Baba Dikme Dekorlu Tapası  75 Koli içi adet | FCS-AKS-0067 70x70 Kare Baba Dikme Kristal Dekorlu Tapa  75 Koli içi adet | FCS-AKS-0068 14x14 Kare Mozaik Dekorlu Tapa  50 Koli içi adet | FCS-AKS-0069 Çiftli Alt Baza Profil Tapası  50 Koli içi adet |
| FCS-AKS-0070 Tekli Alt Baza Profil Tapası  50 Koli içi adet | FCS-AKS-0071 70x70 Kare Baba Dikme Tapası  50 Koli içi adet | FCS-AKS-0072 14x14 Kare Boş 135° Dirsek  100 Koli içi adet | FCS-AKS-0073 14x14 Kare Boş 90° Dirsek  250 Koli içi adet |
| FCS-AKS-0074 14x14 Kare 90° Dirsek  75 Koli içi adet | FCS-AKS-0075 14x14 Kare 135° Dirsek  75 Koli içi adet | FCS-AKS-0076 40x40 Kare Dikme 50'lik Boru Hareketli Kare Dirsek  75 Koli içi adet | FCS-AKS-0077 15 cm Baza Profil  75 Koli içi adet |
| FCS-AKS-0078 Hareketli Yandan Bağlantı Mafsalı  50 Koli içi adet | FCS-AKS-0079 40x40 Kare Dikme Yandan Bağlantı Mafsalı  50 Koli içi adet | FCS-AKS-0080 25x60 - 30x80 Duvar Yandan T Bağlantı Takımı  50 Koli içi adet | FCS-AKS-0081 Kare Dikme Yandan Özel Bağlantı Takımı  50 Koli içi adet |

| | | | |
|---|---|--|--|
| FCS-AKS-0082 25x60 Mafsal Hareketli Köşe Bağlantı Takımı  100 Koli içi adet | FCS-AKS-0083 30x80 Mafsal Hareketli Köşe Bağlantı Takımı  100 Koli içi adet | FCS-AKS-0084 30x80 90° Sağ Hareketli Dönüş  100 Koli içi adet | FCS-AKS-0085 25x60 90° Sağ Hareketli Dönüş  100 Koli içi adet |
| FCS-AKS-0086 25x60 90° Mafsalı Dönüş  100 Koli içi adet | FCS-AKS-0087 25x60 90° Mafsalı Çok Hareketli Dönüş  100 Koli içi adet | FCS-AKS-0088 25x60 90° Mafsalı Sol Dönüş  100 Koli içi adet | FCS-AKS-0089 25x60 90° Mafsalı Sol Dönüş  100 Koli içi adet |
| FCS-AKS-0090 30x90 90° Mafsalı Dönüş  100 Koli içi adet | FCS-AKS-0091 30x90 90° Mafsalı Çok Hareketli Dönüş  100 Koli içi adet | FCS-AKS-0092 30x90 90° Mafsalı Sağ Dönüş  100 Koli içi adet | FCS-AKS-0093 30x90 90° Mafsalı Sol Dönüş  100 Koli içi adet |
| FCS-AKS-0094 25x60 Mafsalı 90° Hareketli Dönüş Takımı  100 Koli içi adet | FCS-AKS-0095 25x60 90° Hareketli Dönüş Takımı  100 Koli içi adet | FCS-AKS-0096 25x60 Çok Açılı Dönüş Takımı  100 Koli içi adet | FCS-AKS-0097 25x60 Mafsalı Çok Açılı Dönüş Takımı  100 Koli içi adet |

| | | | |
|---|---|--|--|
| FCS-AKS-0098 30x90 Mafsallı 90° Hareketli Dönüş Takımı  100 Koli içi adet | FCS-AKS-0099 30x90 90° Hareketli Dönüş Takımı  100 Koli içi adet | FCS-AKS-0100 30x90 Çok Açılı Dönüş Takımı  100 Koli içi adet | FCS-AKS-0101 30x90 Mafsallı Çok Açılı Dönüş Takımı  100 Koli içi adet |
| FCS-AKS-0102 25x60 90° Mafsallı Dolu Dönüş Takımı  100 Koli içi adet | FCS-AKS-0103 90° Dolu Dönüş Takımı  100 Koli içi adet | FCS-AKS-0104 25x60 135° Dönüş Takımı  100 Koli içi adet | FCS-AKS-0105 14x14 Kare Çiftli Emniyet Tutamağı  100 Koli içi adet |
| FCS-AKS-0106 14x14 Kare Emniyet Tutamağı  100 Koli içi adet | FCS-AKS-0107 14x14 Kare Profil Emniyet Tutamağı  100 Koli içi adet | FCS-AKS-0108 Kare Dikme Cam Tutamağı  100 Koli içi adet | FCS-AKS-0109 Kare Dikme Aylanlı Cam Tutamağı  100 Koli içi adet |
| FCS-AKS-0110 30x80 Kare Bilezik  150 Koli içi adet | FCS-AKS-0111 14x14 Kare Emniyet Bileziği  350 Koli içi adet | FCS-AKS-0112 Cam Aparatı Düz ve Gönyeli  600 Koli içi adet | FCS-AKS-0113 Cam Aparatı & Gönyeli Uzun  500 Koli içi adet |

| | | | |
|--|--|--|--|
| FCS-AKS-0114 35'lik Ay Mafsal Takımı  250 Koli içi adet | FCS-AKS-0115 50'lik Yargılı 35'lik Bağlantı (düz)  50 Koli içi adet | FCS-AKS-0116 35'lik Dekorlu Sabit Mafsal  400 Koli içi adet | FCS-AKS-0117 35'lik Yargılı 35'lik Bağlantı (Düz)  50 Koli içi adet |
| FCS-AKS-0118 40'lik Ay Mafsal Takımı  250 Koli içi adet | FCS-AKS-0119 40'lik Ay Mafsal Dışa Geçme  250 Koli içi adet | FCS-AKS-0120 40'lik Ay Mafsal Dışa Geçme  250 Koli içi adet | FCS-AKS-0121 50'lik Yargılı 40'lik Bağlantı (Düz)  50 Koli içi adet |
| FCS-AKS-0122 40'lik Dekorlu Sabit Mafsal  400 Koli içi adet | FCS-AKS-0123 40'lik Sabit Mafsal Dışa Geçme  250 Koli içi adet | FCS-AKS-0124 40'lik Sabit Mafsal Dışa Geçme  250 Koli içi adet | FCS-AKS-0125 40'lik Yargılı 40'lik Bağlantı (Düz)  50 Koli içi adet |
| FCS-AKS-0126 50'lik Bağlantı Mafsal Takımı  150 Koli içi adet | FCS-AKS-0127 50'lik Bağlantı Mafsal Dışa Geçme  150 Koli içi adet | FCS-AKS-0128 50'lik Bağlantı Mafsal Dışa Geçme  150 Koli içi adet | FCS-AKS-0129 50x50 Bağlantı Tırmaklı  250 Koli içi adet |

| | | | |
|--|--|--|---|
| FCS-AKS-0130 35'lik Yer Flanşı  250 Koli içi adet | FCS-AKS-0131 35'lik Duvar & Yer Flanşı  300 Koli içi adet | FCS-AKS-0132 35'lik Dekorlu Flanşı  125 Koli içi adet | FCS-AKS-0133 40'lik Yer Flanşı Tek Tırnak Yeni  500 Koli içi adet |
| FCS-AKS-0134 40'lik Yer Flanşı Tek Tırnak Yeni  500 Koli içi adet | FCS-AKS-0135 40'lik Yer Flanşı Tırnaksız  400 Koli içi adet | FCS-AKS-0136 40'lik Vidalı Yer Flanşı  250 Koli içi adet | FCS-AKS-0137 40'lik Dıştan Vidalı Kapağı  250 Koli içi adet |
| FCS-AKS-0138 40'lik Dekorlu Flanşı  125 Koli içi adet | FCS-AKS-0139 40'lik Dekorlu Ara Flanşı  125 Koli içi adet | FCS-AKS-0140 40'lik Dekorlu Ara Flanşı  125 Koli içi adet | FCS-AKS-0141 40'lik Gönyeli Dikme Yer Flanşı  50 Koli içi adet |
| FCS-AKS-0142 50'lik Duvar Flanşı  100 Koli içi adet | FCS-AKS-0143 50'lik Duvar Flanşı Çift Delik  350 Koli içi adet | FCS-AKS-0144 40'lik Duvar Flanşı  400 Koli içi adet | FCS-AKS-0145 16'lık ve 19'lik Dekorlu Flanşı  50 Koli içi adet |

| | | | |
|---|--|---|---|
| FCS-AKS-0146 50'lik Dikme Yer Flanşı  100 Koli içi adet | FCS-AKS-0147 50'lik Gönyeli Duvar Flanşı  50 Koli içi adet | FCS-AKS-0148 50'lik Dıştan Vidalı  250 Koli içi adet | FCS-AKS-0149 19'lik Duvar Flanşı  50 Koli içi adet |
| FCS-AKS-0150 19'lik Tek Delikli Duvar Flanşı  20 Koli içi adet | FCS-AKS-0151 16'lik Duvar Flanşı  50 Koli içi adet | FCS-AKS-0152 16'lik Tek Delikli Duvar Flanşı  20 Koli içi adet | FCS-AKS-0153 19'lik 3 Boğumlu Ara Dekor  50 Koli içi adet |
| FCS-AKS-0154 16'lik 3 Boğumlu Ara Dekor  50 Koli içi adet | FCS-AKS-0155 50'lik Açı Ayarlı Duvar Flanşı  125 Koli içi adet | FCS-AKS-0156 35'lik Tapa  20 Koli içi adet | FCS-AKS-0157 40'lik Tapa  50 Koli içi adet |
| FCS-AKS-0158 19'lik Vida Gizleme Tapa  100 Koli içi adet | FCS-AKS-0159 16'lik Vida Gizleme Tapa  100 Koli içi adet | FCS-AKS-0160 19'lik Vida Gizleme Tapa Yeni  100 Koli içi adet | FCS-AKS-0161 16'lik Vida Gizleme Tapa Yeni  100 Koli içi adet |

| | | | |
|---|---|---|--|
| FCS-AKS-0162 19'luk Tapa  50 Koli içi adet | FCS-AKS-0163 19'luk Dekorlu Tapa  50 Koli içi adet | FCS-AKS-0164 16'luk Tapa  100 Koli içi adet | FCS-AKS-0165 16'luk Dekorlu Tapa  100 Koli içi adet |
| FCS-AKS-0166 19'luk ve 16'luk Tekli Ara Dekor  10 Koli içi adet | FCS-AKS-0167 19'luk ve 16'luk Dekorlu Küre Tapa  10 Koli içi adet | FCS-AKS-0168 19'luk ve 16'luk Dekorlu Topuz Tapa  10 Koli içi adet | FCS-AKS-0169 50'luk Tapa  500 Koli içi adet |
| FCS-AKS-0170 50'luk Boş Tapa  500 Koli içi adet | FCS-AKS-0171 50'luk Topuz  75 Koli içi adet | FCS-AKS-0172 50'luk Boş Topuz  75 Koli içi adet | FCS-AKS-0173 40'luk Topuz  125 Koli içi adet |
| FCS-AKS-0174 40'luk Kare Topuz  50 Koli içi adet | FCS-AKS-0175 35'luk Topuz  50 Koli içi adet | FCS-AKS-0176 16'luk ve 19'luk Plastik Vida Gizleme Tapası  100 Koli içi adet | FCS-AKS-0177 50'luk Kristal Küre  10 Koli içi adet |

| | | | |
|---|---|--|--|
| FCS-AKS-0178 35'luk Yargılı Duvar Ara Bağlantı  200 Koli içi adet | FCS-AKS-0179 35'luk Pul  10 Koli içi adet | FCS-AKS-0180 40'luk Yargılı Duvar Ara Bağlantı  60 Koli içi adet | FCS-AKS-0181 Duvar Bağlantı Takımı  150 Koli içi adet |
| FCS-AKS-0182 Duvar L Bağlantı  50 Koli içi adet | FCS-AKS-0183 135" Duvar L Bağlantı  50 Koli içi adet | FCS-AKS-0184 135" Duvar L Bağlantı Uzun  50 Koli içi adet | FCS-AKS-0185 Kapı Menteşesi  50 Koli içi adet |
| FCS-AKS-0186 Kapı Sürgüsü  50 Koli içi adet | FCS-AKS-0187 Duvar Ay Bağlantı  10 Koli içi adet | FCS-AKS-0188 Ankraj Demiri Duvar Yandan Bağlantı  50 Koli içi adet | FCS-AKS-0189 100 cm 8 Metrik Gijon  50 Koli içi adet |
| FCS-AKS-0190 Ankraj Demiri Dolu (20 cm)  50 Koli içi adet | FCS-AKS-0191 Boş Ankraj Demiri (20 cm)  50 Koli içi adet | FCS-AKS-0192 Ankraj Demiri Dolu (15 cm)  50 Koli içi adet | FCS-AKS-0193 Boş Ankraj Demiri (15 cm)  50 Koli içi adet |

| | | | |
|---|--|---|--|
| FCS-AKS-0194 Cumba (90 cm)  50 Koli içi adet | FCS-AKS-0195 Somun Pul  50 Koli içi adet | FCS-AKS-0196 19'luk Pul  20 Koli içi adet | FCS-AKS-0197 40'lık Duvar Yandan Bağlantı Tk.  100 Koli içi adet |
| FCS-AKS-0198 35'lik Duvar Yandan Bağlantı Tk.  100 Koli içi adet | FCS-AKS-0199 40'lık Kare Profil Yandan Bağlantı Tk.  100 Koli içi adet | FCS-AKS-0200 40'lık ve 50'lik Duvar Dibi Bağlantı  250 Koli içi adet | FCS-AKS-0201 40'lık Duvar Dibi Bağlantı Uzun  50 Koli içi adet |
| FCS-AKS-0202 16'lık ve 19'luk Boru Tutamağı Düz  25 Koli içi adet | FCS-AKS-0203 Cam Plastikleri  250 Koli içi adet | FCS-AKS-0204 Fitilli Cam Aparatı Kapaklı  300 Koli içi adet | FCS-AKS-0205 Tırmıklı Cam Tutamağı  600 Koli içi adet |
| FCS-AKS-0206 50'lik Bilezik (3cm)  250 Koli içi adet 150 Koli içi adet | FCS-AKS-0207 16'lık ve 19'luk Boru Tutamağı  25 Koli içi adet | FCS-AKS-0208 35'lik ve 40'lik Bilezik  350 Koli içi adet | FCS-AKS-0209 19'luk ve 16'lık Bilezik  25 Koli içi adet |

| | | | |
|---|--|---|--|
| FCS-AKS-0210 50'lik Küre Dirsek (Dolu)  80 Koli içi adet | FCS-AKS-0211 50'lik Küre Dirsek (Boş)  100 Koli içi adet | FCS-AKS-0212 50'lik Küre Dirsek (Boş)  100 Koli içi adet | FCS-AKS-0213 35'lik Mafsallı 50'lik Küre Dirsek (Dolu)  50 Koli içi adet |
| FCS-AKS-0214 35'lik Mafsallı 50'lik Küre Dirsek (Boş)  50 Koli içi adet | FCS-AKS-0215 40'lık Mafsallı 50'lik Küre Dirsek (Dolu)  50 Koli içi adet | FCS-AKS-0216 40'lık Mafsallı 50'lik Küre Dirsek (Boş)  50 Koli içi adet | FCS-AKS-0217 19'luk Küre Dirsek  50 Koli içi adet |
| FCS-AKS-0218 19'luk Küre Dirsek  50 Koli içi adet | FCS-AKS-0219 16'lık Dirsekler 90°  200 Koli içi adet | FCS-AKS-0220 90 Kare Emniyet Şeridi Dirseği Lüks  300 Koli içi adet | FCS-AKS-0221 16'lık Dirsekler 135°  300 Koli içi adet |
| FCS-AKS-0222 135 Kare Emniyet Şeridi Dirseği Lüks  300 Koli içi adet | FCS-AKS-0223 90° Şişirme Dirsek FCS-AKS-0224 45° Şişirme Dirsek  50 75 Koli içi adet | FCS-AKS-0225 90 ve 135° 22'lik Dirsek  50 Koli içi adet | FCS-AKS-0226 16'lık ve 19'luk Şişirme Destek  200 Koli içi adet |

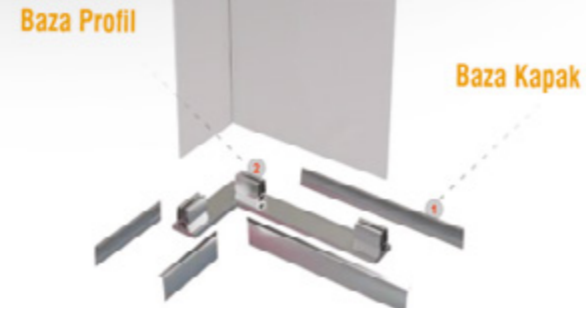
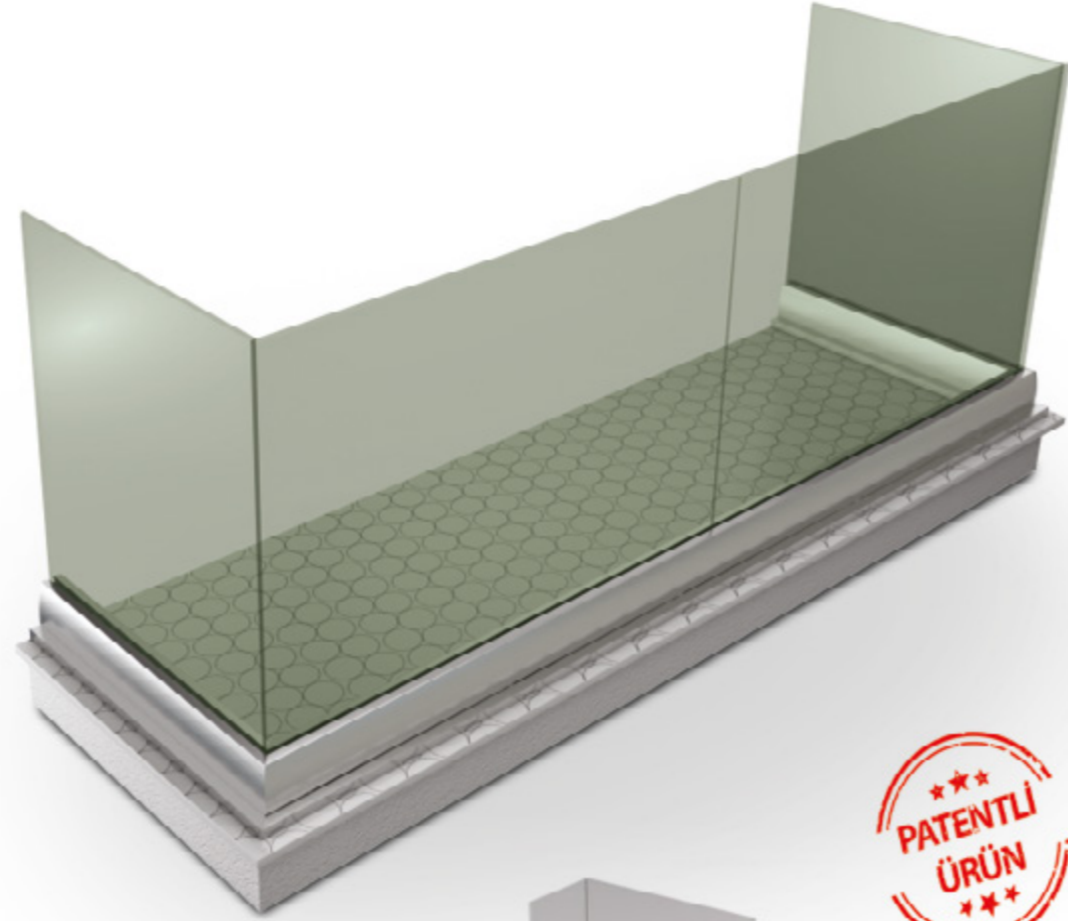

BAZA PROFİL KESİTLERİ VE TEKNİK DETAYLAR

Cam Baza Sistem

FCS-AKS-0227

FCS-AKS-0228



Alüminyum
Kapı Pencere
Aksesuarları



**ERGONOMİK
GÜVENLİ VE
ESTETİK**

KİLİTLİ VE KİLİTSİZ SİSTEM | KOLAY KULLANIM VE MONTAJ
LOCKED AND UNLOCKED SYSTEM - EASE OF USE AND INSTALLATION



**YENİ NESİL
TAK KULLAN
CAM FİTİLİ**

Kolay montaj
Daha iyi izolasyon
Esnek yapı ile hassas birleşim
Uzun ömürlü kullanım

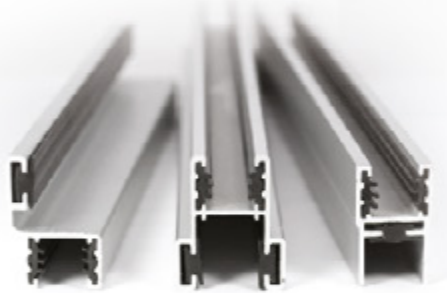

FCS-AKS-0229

FCS-AKS-0230

FCS-AKS-0231

Begüm Pleksi Kol

Pleksi Kol



| KOD | Ø | H |
|--------------|----|-----|
| FCS-AKS-0232 | 30 | 400 |
| FCS-AKS-0233 | 30 | 500 |
| FCS-AKS-0234 | 30 | 600 |

20 Koli içi adet

Begüm Pleksi Kol

Pleksi Kol



| KOD | Ø | H |
|--------------|----|-----|
| FCS-AKS-0235 | 30 | 400 |
| FCS-AKS-0236 | 30 | 500 |
| FCS-AKS-0237 | 30 | 600 |

20 Koli içi adet

Begüm Alü. Kol

Alüminyum Kol



| KOD | Ø | H |
|--------------|----|-----|
| FCS-AKS-0238 | 30 | 400 |
| FCS-AKS-0239 | 30 | 500 |
| FCS-AKS-0240 | 30 | 600 |
| FCS-AKS-0241 | 30 | 700 |
| FCS-AKS-0242 | 30 | 800 |
| FCS-AKS-0243 | 30 | 900 |

20 Koli içi adet

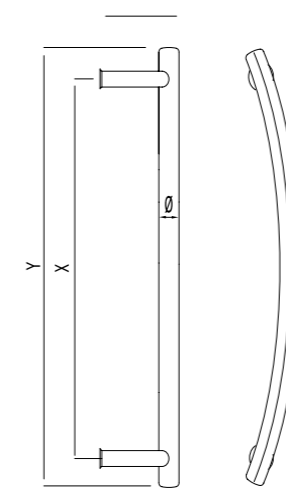

Yay Kol

**20** Koli içi adet**15** Koli içi adet

| KOD | Ø | X | Y | Z | KOD | Ø | X | Y | Z |
|--------------|----|-----|-----|----|--------------|----|------|-----|----|
| FCS-AKS-0244 | 30 | 300 | 340 | 80 | FCS-AKS-0248 | 30 | 700 | 340 | 80 |
| FCS-AKS-0245 | 30 | 400 | 440 | 80 | FCS-AKS-0249 | 30 | 800 | 440 | 80 |
| FCS-AKS-0246 | 30 | 500 | 540 | 80 | FCS-AKS-0250 | 30 | 900 | 540 | 80 |
| FCS-AKS-0247 | 30 | 600 | 640 | 80 | FCS-AKS-0251 | 30 | 1000 | 640 | 80 |

H Kol

Koli içi adet

KOD

| | |
|--------------|----|
| FCS-AKS-0252 | 20 |
| FCS-AKS-0253 | 20 |
| FCS-AKS-0254 | 20 |
| FCS-AKS-0255 | 10 |
| FCS-AKS-0256 | 10 |
| FCS-AKS-0257 | 10 |
| FCS-AKS-0258 | 10 |
| FCS-AKS-0259 | 10 |

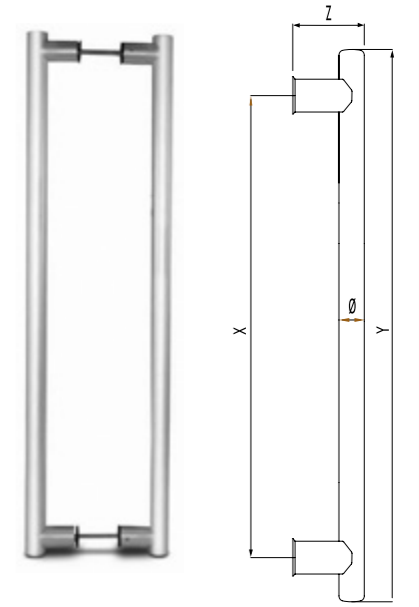

| KOD | X | Y | Z | KOD | Ø | X | Y | Z | |
|--------------|----|-----|-----|-----|--------------|----|------|------|----|
| FCS-AKS-0260 | 30 | 300 | 340 | 80 | FCS-AKS-0264 | 30 | 700 | 740 | 80 |
| FCS-AKS-0261 | 30 | 400 | 440 | 80 | FCS-AKS-0265 | 30 | 800 | 840 | 80 |
| FCS-AKS-0262 | 30 | 500 | 540 | 80 | FCS-AKS-0266 | 30 | 900 | 940 | 80 |
| FCS-AKS-0263 | 30 | 600 | 640 | 80 | FCS-AKS-0267 | 30 | 1000 | 1040 | 80 |

S Kol

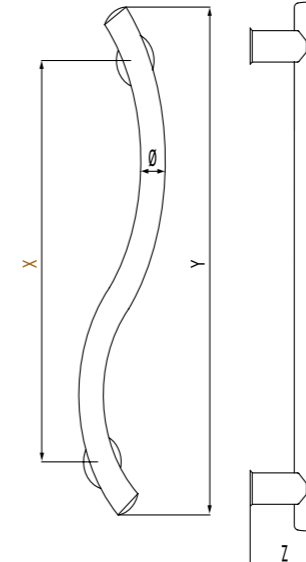
**10** Koli içi adet

| KOD | Ø | X | Y | Z |
|--------------|----|------|------|----|
| FCS-AKS-0268 | 30 | 800 | 840 | 80 |
| FCS-AKS-0269 | 30 | 900 | 940 | 80 |
| FCS-AKS-0270 | 30 | 1000 | 1040 | 80 |

U Çekme Kol

Koli içi adet

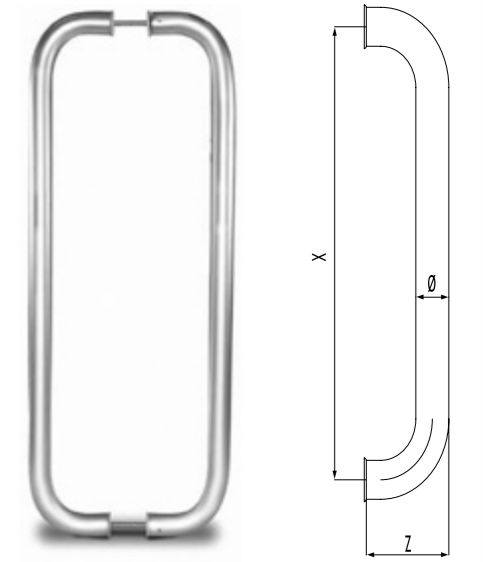
20

| KOD | Ø | X | Z | KOD | Ø | X | Z |
|--------------|----|-----|----|--------------|----|-----|-----|
| FCS-AKS-0271 | 25 | 200 | 80 | FCS-AKS-0275 | 25 | 400 | 80 |
| FCS-AKS-0272 | 25 | 250 | 80 | FCS-AKS-0276 | 25 | 500 | 80 |
| FCS-AKS-0273 | 25 | 300 | 80 | FCS-AKS-0277 | 25 | 600 | 100 |
| FCS-AKS-0274 | 25 | 350 | 80 | FCS-AKS-0278 | 25 | 800 | 100 |
| | | | | FCS-AKS-0279 | 25 | 900 | 100 |

Kıvrık Kol

Koli içi adet

| | |
|--------------|----|
| FCS-AKS-0280 | 15 |
| FCS-AKS-0281 | 25 |
| FCS-AKS-0282 | 25 |
| FCS-AKS-0283 | 25 |
| FCS-AKS-0284 | 20 |
| FCS-AKS-0285 | 20 |
| FCS-AKS-0286 | 20 |
| FCS-AKS-0287 | 20 |

| KOD | Ø | X | Z1 | Z2 | KOD | Ø | X | Z1 | Z2 |
|--------------|----|-----|-----|----|--------------|----|-----|-----|----|
| FCS-AKS-0288 | 25 | 200 | 130 | 80 | FCS-AKS-0292 | 25 | 400 | 130 | 80 |
| FCS-AKS-0289 | 25 | 250 | 130 | 80 | FCS-AKS-0293 | 25 | 450 | 160 | 80 |
| FCS-AKS-0290 | 25 | 300 | 130 | 80 | FCS-AKS-0294 | 25 | 500 | 160 | 80 |
| FCS-AKS-0291 | 25 | 350 | 130 | 80 | FCS-AKS-0295 | 25 | 550 | 160 | 80 |

Baston Kol

10 Koli içi adet

| KOD | Ø | X |
|--------------|----|------|
| FCS-AKS-0296 | 25 | 900 |
| FCS-AKS-0297 | 25 | 1000 |
| FCS-AKS-0298 | 30 | 900 |
| FCS-AKS-0299 | 30 | 1000 |

Lama Bant Kol

Lama Bant Kol

10 Koli içi adet

| KOD | X |
|--------------|------|
| FCS-AKS-0303 | 800 |
| FCS-AKS-0304 | 900 |
| FCS-AKS-0305 | 1000 |

FCS-AKS-0306

Açılı Akbank Kol Apatartı

16 Koli içi adet

32 Koli içi adet

omni metalurji FCS-AKS-0300 Dış Müdahale Panik Kol

omni metalurji FCS-AKS-0301 Tek Kanat Panik Kol













omni metalurji FCS-AKS-0302 Dış Müdahale Panik Kol













FCS-AKS-0307











Açılı Akbank Kol

FCS-AKS-0308

Havuz Tip Akbank Kol

| | | |
|--|---|---|
| FCS-AKS-0309 Mini U Kol Aynalı  75 Koli içi adet | FCS-AKS-0310 Mini U Kol Takım  75 Koli içi adet | FCS-AKS-0311 Mini Kıvrık Kol Aynalı  50 Koli içi adet |
| FCS-AKS-0312 Mini Kıvrık Kol Takım  50 Koli içi adet | FCS-AKS-0313 Döküm Yarım Ay Kol Ekolsal  50 Koli içi adet | FCS-AKS-0314 Döküm Yarım Ay Kol Boyalı  50 Koli içi adet |
| FCS-AKS-0315 Kare Kol  100 Koli içi adet | FCS-AKS-0316 C Kol  250 Koli içi adet | FCS-AKS-0317 D Kol  250 Koli içi adet |
| FCS-AKS-0318 Tetik Kol  75 Koli içi adet | FCS-AKS-0319 Sosis Kol  75 Koli içi adet | FCS-AKS-0320 Sosis Kol Yaylı Rozetli  75 Koli içi adet |



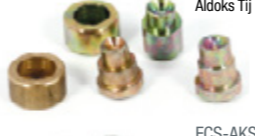



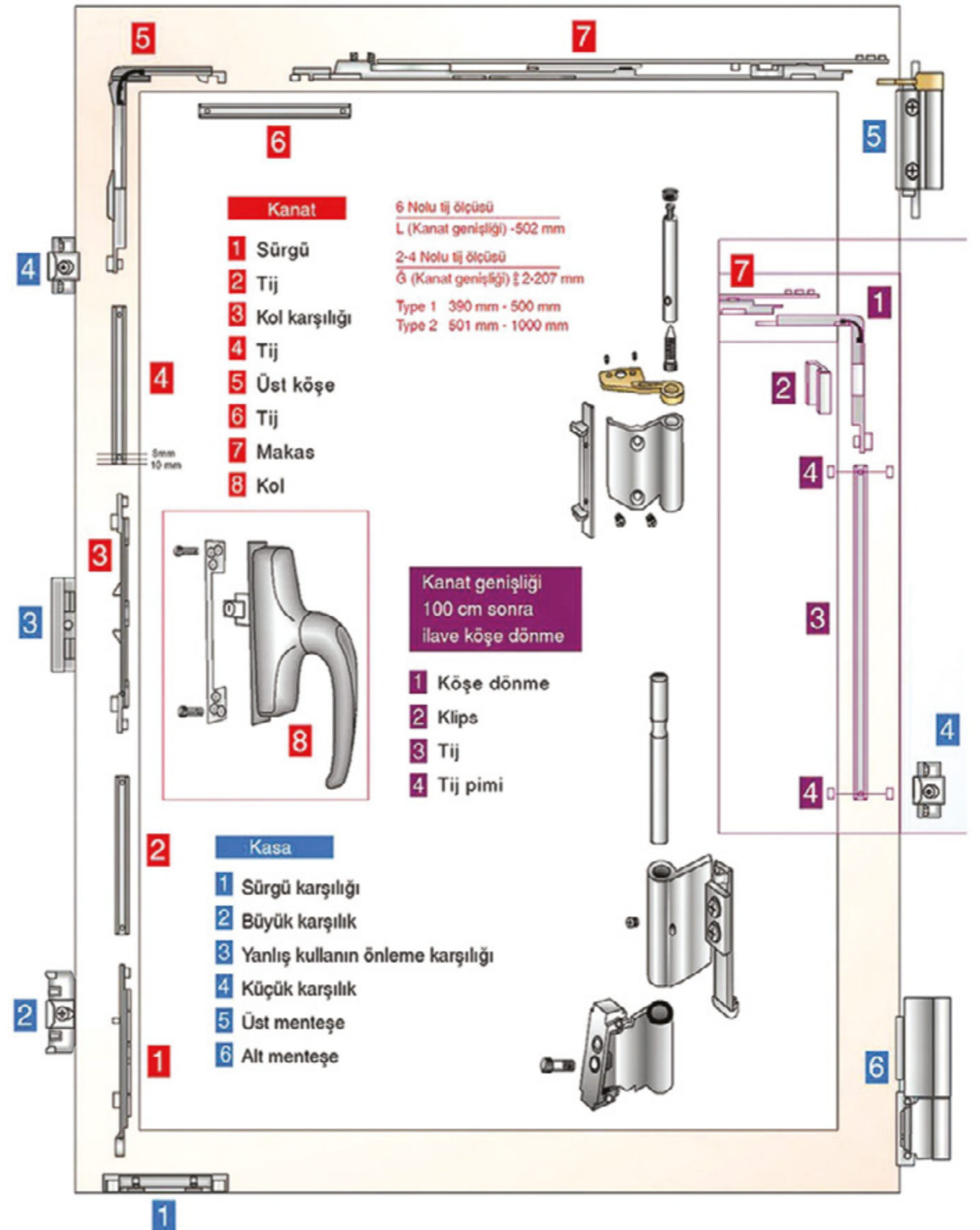



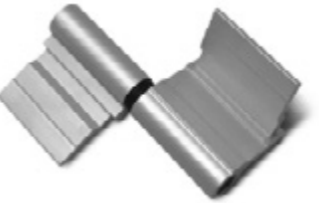

| | | |
|--|---|--|
| FCS-AKS-0321 Sosis Kol Rozetli  75 Koli içi adet | FCS-AKS-0322 Aynalı Sosis Kol  40 Koli içi adet | FCS-AKS-0323 A.Yaylı Basma K.Kollu Lüks  40 Koli içi adet |
| FCS-AKS-0324 A.Yaylı Basma Kapı Kolu  40 Koli içi adet | FCS-AKS-0325 Rozet  100 Koli içi adet | FCS-AKS-0326 Kilitli Eksenel Kol  30 Koli içi adet |
| FCS-AKS-0327 İspanyolet Kol  125 Koli içi adet | FCS-AKS-0328 Eksenel Kol Tek Dilli  75 Koli içi adet | FCS-AKS-0329 Eksenel Kol Çift Dilli  75 Koli içi adet |
| FCS-AKS-0330 Köşeli Eksenel Kol  75 Koli içi adet | FCS-AKS-0331 PaFCSK İzli İspanyolet Kol  100 Koli içi adet | FCS-AKS-0332 Gizli Kanat Kol  50 Koli içi adet |

| | | |
|--|--|---|
| FCS-AKS-0333 Düz Master Kol | FCS-AKS-0334 Düz Master Kol Taban | FCS-AKS-0335 Düz Master Kol Takım |
|  75 Koli içi adet |  40 Koli içi adet |  40 Koli içi adet |
| FCS-AKS-0336 Boyunlu Master Kol | FCS-AKS-0337 Boyunlu Master Kol Taban | FCS-AKS-0338 Boyunlu Master Kol Takım |
|  40 Koli içi adet |  100 Koli içi adet |  30 Koli içi adet |
| FCS-AKS-0339 Kıvrık Cephe Kolu Tek Dilli | FCS-AKS-0340 Kıvrık Cephe Kolu Çift Dilli | FCS-AKS-0341 Yaylı Kapı Kolu (Metal Tabanlı) |
|  125 Koli içi adet |  75 Koli içi adet |  75 Koli içi adet |
| FCS-AKS-0342 FCS-AKS-0343 Habeschebe KaldıFCSlı S.Kol | FCS-AKS-0344 Habeschebe K.Sürme Havuz Kol | FCS-AKS-0345 FCS-AKS-0346 Aldoks Tij Pimi |
|  FCS-AKS-0342 Habeschebe KaldıFCSlı Sürme Kol (Barelli) FCS-AKS-0343 Habeschebe KaldıFCSlı Sürme Kol (Kısa Tip) 75 Koli içi adet |  100 Koli içi adet |  FCS-AKS-0345 Aldoks Tij Pimi FCS-AKS-0346 Isı Yalıtım (Sistem) Tij Pimi 8 mm 100 Koli içi adet |

ÇİFT AÇILIM MEKANİZMASI



| | | |
|---|---|---|
| FCS-AKS-0347 Aldoks Kilit Karşılığı Dilli  640 Koli içi adet | FCS-AKS-0348 Aldoks Kilit Karşılığı Makaralı  640 Koli içi adet | FCS-AKS-0349 Sistem Kilit Karşılığı Dilli  640 Koli içi adet |
| FCS-AKS-0350 FCS-AKS-0351 Sistem Kilit Karşılığı Makaralı Uzun Sistem Kilit Karşılığı Dilli(Uzun)  800 Koli içi adet | FCS-AKS-0352 Sistem Kilit Karşılığı Makaralı  400 Koli içi adet | FCS-AKS-0353 FCS-AKS-0354 C60 Kilit Karşılığı Makaralı C60 Kilit Karşılığı Dilli  400 Koli içi adet |
| FCS-AKS-0355 C60 Kilit Altı  280 Koli içi adet | FCS-AKS-0356 C60 Elektrikli Kilit Altı  280 Koli içi adet | FCS-AKS-0357 Ayarlı Cephe Karşılığı  500 Koli içi adet |
| FCS-AKS-0358 Ayarlı Cephe Karşılığı  500 Koli içi adet | FCS-AKS-0359 Ayarlı Zamak Karşılık  500 Koli içi adet | FCS-AKS-0360 FCS-AKS-0361 Yunan Alyan Bağlantı  FCS-AKS-0360 Yunan Alyan Bağlantı Zamak 24 mm FCS-AKS-0361 Yunan Alyan Balantı Zamak 26 mm 500 Koli içi adet |

| | | |
|---|--|---|
| FCS-AKS-0362 Aldoks Mentеше  300 Koli içi adet | FCS-AKS-0363 Aldoks Mentеше Uzun  300 Koli içi adet | FCS-AKS-0364 Aldoks Mentеше Tip 2  300 Koli içi adet |
| FCS-AKS-0365 Aldoks Üstten Basma Mentеше  300 Koli içi adet | FCS-AKS-0366 C60 Mentеше  120 Koli içi adet | FCS-AKS-0367 Kapazlama Mentеше  80 Koli içi adet |
| FCS-AKS-0368 ARWIS PVC Sistem Mentеше  250 Koli içi adet | FCS-AKS-0369 ARWIS Sistem Mentеше  250 Koli içi adet | FCS-AKS-0370 Sistem Mentеше  200 Koli içi adet |
| FCS-AKS-0371 Sanay-Asaş-Sistem Mentеше  200 Koli içi adet | FCS-AKS-0372 Pivot Mentеше  100 Koli içi adet | FCS-AKS-0373 Hemyüz Sistem Mentеше  120 Koli içi adet |

| | | |
|---|---|---|
| FCS-AKS-0372 Fugualı Mentеше | FCS-AKS-0373 Isı Yalıtım İzö Mentеше | FCS-AKS-0374 FCS-AKS-0375 33'lük - 36'lük Çarpma Menteşe ve ve Çıtası |
|  120 Koli içi adet |  200 Koli içi adet |  25 Koli içi adet FCS-AKS-0374 33'lük Çarpma Menteşe ve ve Çıtası 16 Koli içi adet FCS-AKS-0375 36'lük Çarpma Menteşe ve ve Çıtası 16 Koli içi adet |
| FCS-AKS-0376 Ald. Vasistas Makası 13 cm | FCS-AKS-0377 Sistem Vasistas | FCS-AKS-0378 Aldoks Çıt Çıt |
|  300 Koli içi adet |  300 Koli içi adet |  300 Koli içi adet |
| FCS-AKS-0379 Kapı Stopları | FCS-AKS-0380 Vasistas Çarpma | Tij Çubuğu |
|  300 Koli içi adet |  300 Koli içi adet |  FCS-AKS-0381 Tij Çubuğu 60 cm FCS-AKS-0382 Tij Çubuğu 75 cm FCS-AKS-0383 Tij Çubuğu 100 cm 100 Koli içi adet |
| FCS-AKS-0384 Demirci 36mm Yaylı Mentеше | FCS-AKS-0385 FCS-AKS-0386 Kapı Altı Fırçası Alttan (T) Kapı Altı Fırçası Alttan (H) | FCS-AKS-0387 Ahşap Fırça |
|  300 Koli içi adet |  100 Koli içi adet |  10 Koli içi adet |

| | | |
|---|---|--|
| FCS-AKS-0388 Fişek Sürğü | FCS-AKS-0389 Aldoks Gömme Sürğü | FCS-AKS-0390 Sistem Uzun Sürğü Geniş |
|  250 Koli içi adet |  300 Koli içi adet |  90 Koli içi adet |
| FCS-AKS-0391 Sistem Uzun Sürğü Dar | FCS-AKS-0392 FCS-AKS-0393 Sistem Kısa Sürğü Geniş Sistem Kısa Sürğü Dar | FCS-AKS-0394 C60 Çiftli Sürğü |
|  90 Koli içi adet |  90 Koli içi adet |  90 Koli içi adet |
| FCS-AKS-0395 Ayarlı Karşılık | FCS-AKS-0396 Aldoks PIS Karşılık | FCS-AKS-0397 Hoppe Kol |
|  120 Koli içi adet |  200 Koli içi adet |  50 Koli içi adet |
| FCS-AKS-0398 Toros Kilit | FCS-AKS-0399 PVC İspanyolet | FCS-AKS-0400 PVC İspanyolet |
|  25 Koli içi adet |  25 Koli içi adet |  25 Koli içi adet |

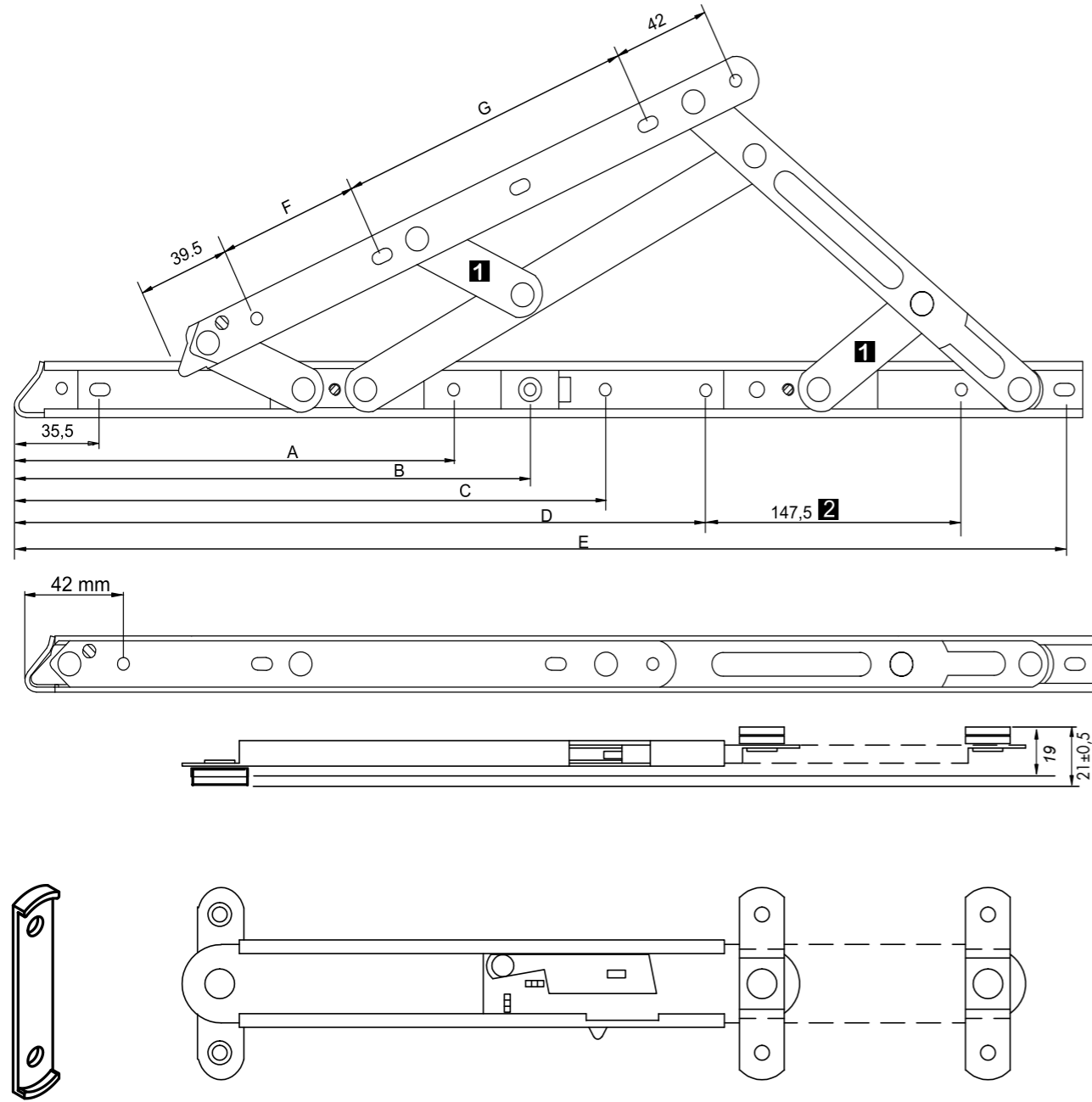





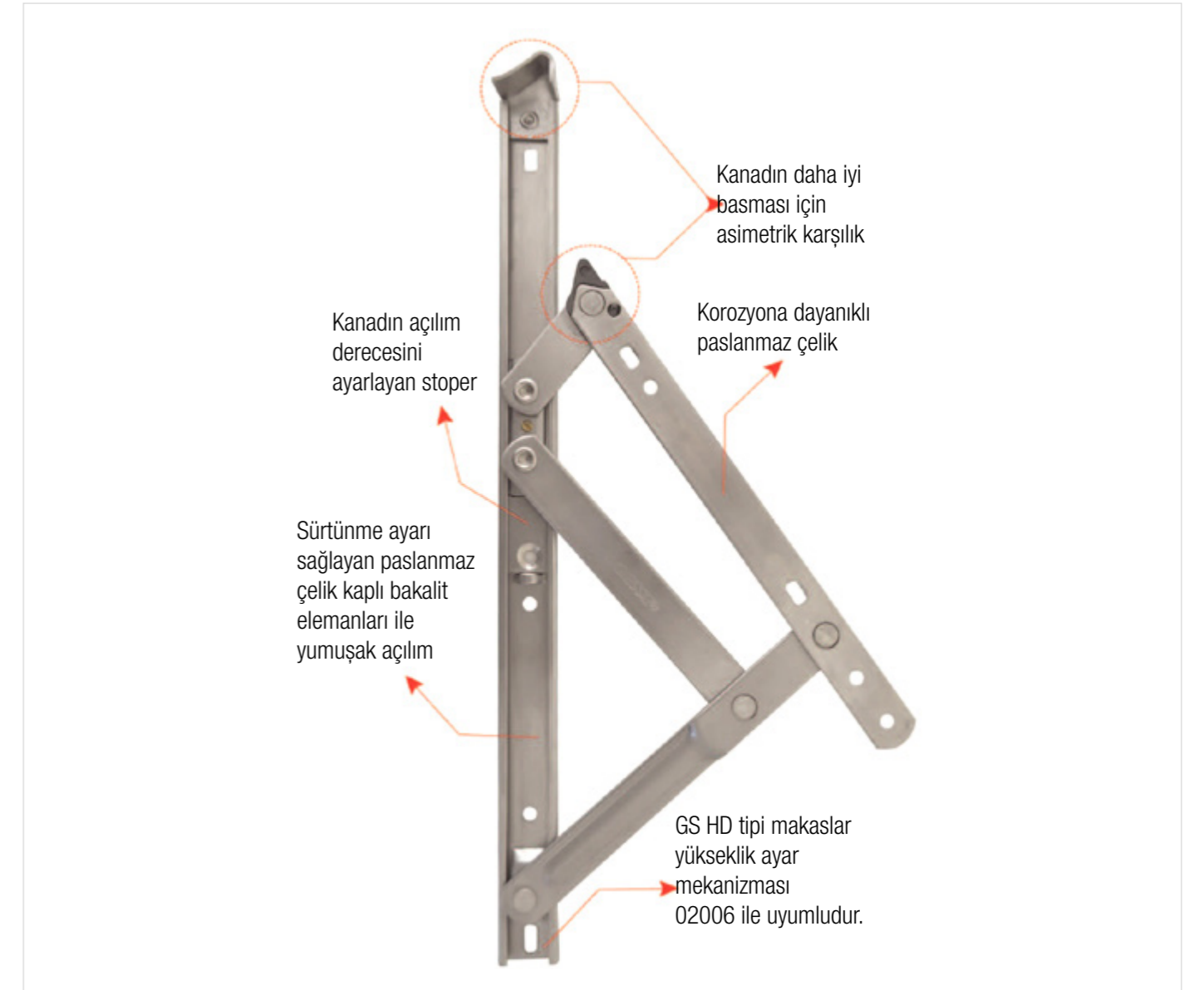







SIEGENIA Cephe Makasları













| Ürün Kodu | Artikül | inc / Uzunluk | Max.Yükseklik | Max.Genişlik | Taş.Kapasitesi | Max.Açı |
|--------------|-----------------|---------------|------------------|--------------|----------------|---------|
| FCS-AKS-0401 | CSHD8600-000110 | 14 (355 mm) | 1000 | 1300 | 68 KG | 30/35 |
| FCS-AKS-0402 | CSHD8610-000110 | 16 (406 mm) | 1200 | 1400 | 85 KG | 25/30 |
| FCS-AKS-0403 | CSHD8620-000110 | 18 (457 mm) | 1400 | 1400 | 95 KG | 25/30 |
| FCS-AKS-0404 | CSHD8630-000110 | 20 (508 mm) | 1600 | 1500 | 108 KG | 20/25 |
| FCS-AKS-0405 | CSHD8340-000150 | 22 (559 mm) | 1700 | 1800 | 112 KG | 20/25 |
| FCS-AKS-0406 | CSHD8650-000110 | 24 (609 mm) | 1800 | 1600 | 120 KG | 20/25 |
| FCS-AKS-0407 | CSHD8360-000150 | 26 (660 mm) | 1900 | 1900 | 125 KG | 20/25 |
| FCS-AKS-0408 | CSHD8370-000150 | 28 (711 mm) | 2000 | 2000 | 130 KG | 20 |
| FCS-AKS-0409 | CASA8040-000061 | 6 (152 mm) | TELESKOPIK MAKAS | | | |
| FCS-AKS-0410 | CASA8050-000060 | 8 (203 mm) | TELESKOPIK MAKAS | | | |
| FCS-AKS-0411 | CASA8060-000060 | 10 (254 mm) | TELESKOPIK MAKAS | | | |





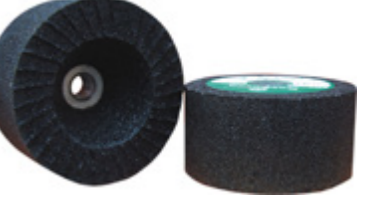





GIESSE Cephe Makasları



| Ürün Kodu | Makas Tipi | Makas Kanat Yüksekliği | Makas Kanat Genişliği | Makas Kanat Ağırlığı | Koli İçi Adet |
|--------------|---------------------|------------------------|-----------------------|----------------------|---------------|
| FCS-AKS-0412 | 12"lik Cephe Makası | 800 | 1200 | 60 | 6 Ad. |
| FCS-AKS-0413 | 14"lük Cephe Makası | 1000 | 1300 | 69,50 | 6 Ad. |
| FCS-AKS-0414 | 16"lik Cephe Makası | 1200 | 1400 | 88,50 | 6 Ad. |
| FCS-AKS-0415 | 18"lik Cephe Makası | 1400 | 1400 | 102 | 6 Ad. |
| FCS-AKS-0416 | 20"lik Cephe Makası | 1600 | 1500 | 135 | 6 Ad. |
| FCS-AKS-0417 | 22"lik Cephe Makası | 1700 | 1500 | 137 | 6 Ad. |
| FCS-AKS-0418 | 24"lük Cephe Makası | 1800 | 1500 | 139 | 6 Ad. |
| FCS-AKS-0419 | 28"lik Cephe Makası | 2000 | 1500 | 155 | 6 Ad. |

| | | | | | |
|---|--------------------------------------|---|---------------------------|--|-------------------------|
| FCS-AKS-0420 | Kale 157 A Tirajlı Demir Kapı Kilidi | FCS-AKS-0421 | Kale 157 El Tirajlı Kilit | FCS-AKS-0422 | Otomatsan Tirajlı Kilit |
|  | |  | |  | |
| FCS-AKS-0423 | Mert Kapı İtme Yayı | FCS-AKS-0424 | Kale Kilit 157 F | FCS-AKS-0425 | Kapı Hidroliği |
|  | |  | |  | |
| FCS-AKS-0426 | Kale Kilit 152R | FCS-AKS-0427 | Kale 151 R Oda Kilidi | FCS-AKS-0428 | Tij Çubuğu 60 cm |
|  | |  | |  | |
| FCS-AKS-0429 | Kale Bilyeli Barel | FCS-AKS-0430 | Kale Kör Barel | FCS-AKS-0431 | Barel |
|  | |  | |  | |

| FCS-AKS-0432 | Sineklik Tül Çeşitleri | FCS-AKS-0436 | Kimyasal Dübel Tabancası | FCS-AKS-0437 | Silikon Tabancası | | | | | | | | | |
|---|--|---|---------------------------------------|---|---|--------------|-----|--------------|-----|--------------|-----|---|---|--|
|  | <table border="1"> <thead> <tr> <th>KOD</th> <th>cm</th> </tr> </thead> <tbody> <tr> <td>FCS-AKS-0432</td> <td>80</td> </tr> <tr> <td>FCS-AKS-0433</td> <td>100</td> </tr> <tr> <td>FCS-AKS-0434</td> <td>120</td> </tr> <tr> <td>FCS-AKS-0435</td> <td>140</td> </tr> </tbody> </table> | KOD | cm | FCS-AKS-0432 | 80 | FCS-AKS-0433 | 100 | FCS-AKS-0434 | 120 | FCS-AKS-0435 | 140 |  |  | |
| KOD | cm | | | | | | | | | | | | | |
| FCS-AKS-0432 | 80 | | | | | | | | | | | | | |
| FCS-AKS-0433 | 100 | | | | | | | | | | | | | |
| FCS-AKS-0434 | 120 | | | | | | | | | | | | | |
| FCS-AKS-0435 | 140 | | | | | | | | | | | | | |
| FCS-AKS-0438 | Karbosan AA 24 S BF80-INOX | FCS-AKS-0439 | Karbosan C24 S BF80 | FCS-AKS-0440 | Karbosan Plus A30 Q BF80 | | | | | | | | | |
|  | |  | |  | | | | | | | | | | |
| FCS-AKS-0441 | Karbosan A 36 T BF80 Metal | FCS-AKS-0442 | Green Brand Aluminium Oxide Flap Disc | FCS-AKS-0443 | Karbosan Mozaik Silme Taşı SC Düz Çanak | | | | | | | | | |
|  | |  | |  | | | | | | | | | | |
| FCS-AKS-0444 | Karbosan Çanak Taşı Konik 100 mm | FCS-AKS-0445 | Karbosan Plus C36 Q BF80 Marble | FCS-AKS-0446 | Karbosan Turbo Elmas Kesici | | | | | | | | | |
|  | |  | |  | | | | | | | | | | |

| | | |
|---|---|---|
| FCS-AKS-0447 Kompozit Derz Bıçağı | FCS-AKS-0448 Edesso Alm Bıçağı | FCS-AKS-0449 Granit Kesme |
|  |  |  |
| FCS-AKS-0450 Pimli Emniyet Kili | FCS-AKS-0451 Çevirmeli Emniyet Kili | FCS-AKS-0452 Manuel Emniyet Mandalı |
|  |  |  |
| 200 Koli içi adet | 200 Koli içi adet | 150 Koli içi adet |
| FCS-AKS-0453 Ankraj Bağlantı Demirleri | FCS-AKS-0454 Zıvana | FCS-AKS-0455 Ankraj Bağlantı Demiri U |
|  |  |  |
| 250 Koli içi adet | 300 Koli içi adet | 300 Koli içi adet |
| FCS-AKS-0456 Ankraj Bağlantı Demiri L | FCS-AKS-0457 Panjur İpi | FCS-AKS-0458 Somunlar |
|  |  |  |
| 150 Koli içi adet | 150 Koli içi adet | |

| Gijonlar M8 Grubu | Gijonlar M10 Grubu | Gijonlar M12 Grubu | | | | | | | | | | | | | | | | | | | | | | | | | | | | | | | | | | | | | | | | | | | | | | | | | | | | | | | | | | | | | | | | | | | | | | | | | | | | | | | | | | | | | | | | |
|--|---|---|----------|--------------|--------------|---------|--------------|-------|--------------|--------------|----------|-------|--------------|---------|----------|--------------|--------------|---------|---|-------|--------------|----------|--------------|-------|--------------|---|----------|-------|---|--------------|------|---------|--|--------------|---------|--------------|---------|--------------|--------------|----------|-------|--------------|---------|----------|-------|--------------|---------|----------|-------|---|---------|------|---------|--------------|--------------|---------|----------|--------------|--------------|---------|----------|--|-----|------|---------|---------|--------------|-----------|----------|---------|--------------|-----------|----------|---------|--------------|---------|-----|-------|--------------|---------|-----|-------|--------------|----------|----|-------|--------------|----------|----|-------|
|  |  |  | | | | | | | | | | | | | | | | | | | | | | | | | | | | | | | | | | | | | | | | | | | | | | | | | | | | | | | | | | | | | | | | | | | | | | | | | | | | | | | | | | | | | | | | |
| <table border="1"> <thead> <tr> <th>KOD</th> <th>ÖLÇÜ</th> <th>ADET</th> <th>KAPLAMA</th> </tr> </thead> <tbody> <tr><td>FCS-AKS-0459</td><td>M8x500</td><td>50</td><td>BEYAZ</td></tr> <tr><td>FCS-AKS-0460</td><td>M8x650</td><td>50</td><td>BEYAZ</td></tr> <tr><td>FCS-AKS-0461</td><td>M8x1000</td><td>50</td><td>BEYAZ</td></tr> <tr><td>FCS-AKS-0462</td><td>M8x1100</td><td>50</td><td>BEYAZ</td></tr> <tr><td>FCS-AKS-0463</td><td>M8x1200</td><td>50</td><td>BEYAZ</td></tr> <tr><td>FCS-AKS-0464</td><td>M8x1500</td><td>50</td><td>BEYAZ</td></tr> <tr><td>FCS-AKS-0465</td><td>M8x2000</td><td>50</td><td>BEYAZ</td></tr> </tbody> </table> | KOD | ÖLÇÜ | ADET | KAPLAMA | FCS-AKS-0459 | M8x500 | 50 | BEYAZ | FCS-AKS-0460 | M8x650 | 50 | BEYAZ | FCS-AKS-0461 | M8x1000 | 50 | BEYAZ | FCS-AKS-0462 | M8x1100 | 50 | BEYAZ | FCS-AKS-0463 | M8x1200 | 50 | BEYAZ | FCS-AKS-0464 | M8x1500 | 50 | BEYAZ | FCS-AKS-0465 | M8x2000 | 50 | BEYAZ | <table border="1"> <thead> <tr> <th>KOD</th> <th>ÖLÇÜ</th> <th>ADET</th> <th>KAPLAMA</th> </tr> </thead> <tbody> <tr><td>FCS-AKS-0466</td><td>M10x100</td><td>500</td><td>BEYAZ</td></tr> <tr><td>FCS-AKS-0467</td><td>M10x120</td><td>500</td><td>BEYAZ</td></tr> <tr><td>FCS-AKS-0468</td><td>M10x150</td><td>400</td><td>BEYAZ</td></tr> <tr><td>FCS-AKS-0469</td><td>M10x200</td><td>300</td><td>BEYAZ</td></tr> <tr><td>FCS-AKS-0470</td><td>M10x1000</td><td>50</td><td>BEYAZ</td></tr> <tr><td>FCS-AKS-0471</td><td>M10x2000</td><td>50</td><td>BEYAZ</td></tr> </tbody> </table> | KOD | ÖLÇÜ | ADET | KAPLAMA | FCS-AKS-0466 | M10x100 | 500 | BEYAZ | FCS-AKS-0467 | M10x120 | 500 | BEYAZ | FCS-AKS-0468 | M10x150 | 400 | BEYAZ | FCS-AKS-0469 | M10x200 | 300 | BEYAZ | FCS-AKS-0470 | M10x1000 | 50 | BEYAZ | FCS-AKS-0471 | M10x2000 | 50 | BEYAZ | <table border="1"> <thead> <tr> <th>KOD</th> <th>ÖLÇÜ</th> <th>ADET</th> <th>KAPLAMA</th> </tr> </thead> <tbody> <tr><td>FCS-AKS-0472</td><td>M12x100</td><td>500</td><td>BEYAZ</td></tr> <tr><td>FCS-AKS-0473</td><td>M12x120</td><td>500</td><td>BEYAZ</td></tr> <tr><td>FCS-AKS-0474</td><td>M12x150</td><td>300</td><td>BEYAZ</td></tr> <tr><td>FCS-AKS-0475</td><td>M12x200</td><td>200</td><td>BEYAZ</td></tr> <tr><td>FCS-AKS-0476</td><td>M12x1000</td><td>50</td><td>BEYAZ</td></tr> <tr><td>FCS-AKS-0477</td><td>M12x2000</td><td>25</td><td>BEYAZ</td></tr> </tbody> </table> | KOD | ÖLÇÜ | ADET | KAPLAMA | FCS-AKS-0472 | M12x100 | 500 | BEYAZ | FCS-AKS-0473 | M12x120 | 500 | BEYAZ | FCS-AKS-0474 | M12x150 | 300 | BEYAZ | FCS-AKS-0475 | M12x200 | 200 | BEYAZ | FCS-AKS-0476 | M12x1000 | 50 | BEYAZ | FCS-AKS-0477 | M12x2000 | 25 | BEYAZ |
| KOD | ÖLÇÜ | ADET | KAPLAMA | | | | | | | | | | | | | | | | | | | | | | | | | | | | | | | | | | | | | | | | | | | | | | | | | | | | | | | | | | | | | | | | | | | | | | | | | | | | | | | | | | | | | | | |
| FCS-AKS-0459 | M8x500 | 50 | BEYAZ | | | | | | | | | | | | | | | | | | | | | | | | | | | | | | | | | | | | | | | | | | | | | | | | | | | | | | | | | | | | | | | | | | | | | | | | | | | | | | | | | | | | | | | |
| FCS-AKS-0460 | M8x650 | 50 | BEYAZ | | | | | | | | | | | | | | | | | | | | | | | | | | | | | | | | | | | | | | | | | | | | | | | | | | | | | | | | | | | | | | | | | | | | | | | | | | | | | | | | | | | | | | | |
| FCS-AKS-0461 | M8x1000 | 50 | BEYAZ | | | | | | | | | | | | | | | | | | | | | | | | | | | | | | | | | | | | | | | | | | | | | | | | | | | | | | | | | | | | | | | | | | | | | | | | | | | | | | | | | | | | | | | |
| FCS-AKS-0462 | M8x1100 | 50 | BEYAZ | | | | | | | | | | | | | | | | | | | | | | | | | | | | | | | | | | | | | | | | | | | | | | | | | | | | | | | | | | | | | | | | | | | | | | | | | | | | | | | | | | | | | | | |
| FCS-AKS-0463 | M8x1200 | 50 | BEYAZ | | | | | | | | | | | | | | | | | | | | | | | | | | | | | | | | | | | | | | | | | | | | | | | | | | | | | | | | | | | | | | | | | | | | | | | | | | | | | | | | | | | | | | | |
| FCS-AKS-0464 | M8x1500 | 50 | BEYAZ | | | | | | | | | | | | | | | | | | | | | | | | | | | | | | | | | | | | | | | | | | | | | | | | | | | | | | | | | | | | | | | | | | | | | | | | | | | | | | | | | | | | | | | |
| FCS-AKS-0465 | M8x2000 | 50 | BEYAZ | | | | | | | | | | | | | | | | | | | | | | | | | | | | | | | | | | | | | | | | | | | | | | | | | | | | | | | | | | | | | | | | | | | | | | | | | | | | | | | | | | | | | | | |
| KOD | ÖLÇÜ | ADET | KAPLAMA | | | | | | | | | | | | | | | | | | | | | | | | | | | | | | | | | | | | | | | | | | | | | | | | | | | | | | | | | | | | | | | | | | | | | | | | | | | | | | | | | | | | | | | |
| FCS-AKS-0466 | M10x100 | 500 | BEYAZ | | | | | | | | | | | | | | | | | | | | | | | | | | | | | | | | | | | | | | | | | | | | | | | | | | | | | | | | | | | | | | | | | | | | | | | | | | | | | | | | | | | | | | | |
| FCS-AKS-0467 | M10x120 | 500 | BEYAZ | | | | | | | | | | | | | | | | | | | | | | | | | | | | | | | | | | | | | | | | | | | | | | | | | | | | | | | | | | | | | | | | | | | | | | | | | | | | | | | | | | | | | | | |
| FCS-AKS-0468 | M10x150 | 400 | BEYAZ | | | | | | | | | | | | | | | | | | | | | | | | | | | | | | | | | | | | | | | | | | | | | | | | | | | | | | | | | | | | | | | | | | | | | | | | | | | | | | | | | | | | | | | |
| FCS-AKS-0469 | M10x200 | 300 | BEYAZ | | | | | | | | | | | | | | | | | | | | | | | | | | | | | | | | | | | | | | | | | | | | | | | | | | | | | | | | | | | | | | | | | | | | | | | | | | | | | | | | | | | | | | | |
| FCS-AKS-0470 | M10x1000 | 50 | BEYAZ | | | | | | | | | | | | | | | | | | | | | | | | | | | | | | | | | | | | | | | | | | | | | | | | | | | | | | | | | | | | | | | | | | | | | | | | | | | | | | | | | | | | | | | |
| FCS-AKS-0471 | M10x2000 | 50 | BEYAZ | | | | | | | | | | | | | | | | | | | | | | | | | | | | | | | | | | | | | | | | | | | | | | | | | | | | | | | | | | | | | | | | | | | | | | | | | | | | | | | | | | | | | | | |
| KOD | ÖLÇÜ | ADET | KAPLAMA | | | | | | | | | | | | | | | | | | | | | | | | | | | | | | | | | | | | | | | | | | | | | | | | | | | | | | | | | | | | | | | | | | | | | | | | | | | | | | | | | | | | | | | |
| FCS-AKS-0472 | M12x100 | 500 | BEYAZ | | | | | | | | | | | | | | | | | | | | | | | | | | | | | | | | | | | | | | | | | | | | | | | | | | | | | | | | | | | | | | | | | | | | | | | | | | | | | | | | | | | | | | | |
| FCS-AKS-0473 | M12x120 | 500 | BEYAZ | | | | | | | | | | | | | | | | | | | | | | | | | | | | | | | | | | | | | | | | | | | | | | | | | | | | | | | | | | | | | | | | | | | | | | | | | | | | | | | | | | | | | | | |
| FCS-AKS-0474 | M12x150 | 300 | BEYAZ | | | | | | | | | | | | | | | | | | | | | | | | | | | | | | | | | | | | | | | | | | | | | | | | | | | | | | | | | | | | | | | | | | | | | | | | | | | | | | | | | | | | | | | |
| FCS-AKS-0475 | M12x200 | 200 | BEYAZ | | | | | | | | | | | | | | | | | | | | | | | | | | | | | | | | | | | | | | | | | | | | | | | | | | | | | | | | | | | | | | | | | | | | | | | | | | | | | | | | | | | | | | | |
| FCS-AKS-0476 | M12x1000 | 50 | BEYAZ | | | | | | | | | | | | | | | | | | | | | | | | | | | | | | | | | | | | | | | | | | | | | | | | | | | | | | | | | | | | | | | | | | | | | | | | | | | | | | | | | | | | | | | |
| FCS-AKS-0477 | M12x2000 | 25 | BEYAZ | | | | | | | | | | | | | | | | | | | | | | | | | | | | | | | | | | | | | | | | | | | | | | | | | | | | | | | | | | | | | | | | | | | | | | | | | | | | | | | | | | | | | | | |
| Pullar 55'lik Şase Pulu | Pullar 50'lik Şase Pulu | Pullar 65'lik Şase Pulu | | | | | | | | | | | | | | | | | | | | | | | | | | | | | | | | | | | | | | | | | | | | | | | | | | | | | | | | | | | | | | | | | | | | | | | | | | | | | | | | | | | | | | | | |
|  |  |  | | | | | | | | | | | | | | | | | | | | | | | | | | | | | | | | | | | | | | | | | | | | | | | | | | | | | | | | | | | | | | | | | | | | | | | | | | | | | | | | | | | | | | | | |
| <table border="1"> <thead> <tr> <th>KOD</th> <th>ÖLÇÜ</th> <th>KAPLAMA</th> <th>PAKET</th> </tr> </thead> <tbody> <tr><td>FCS-AKS-0478</td><td>55x11x4</td><td>GALVANİZ</td><td>25 KG</td></tr> <tr><td>FCS-AKS-0479</td><td>55x13x4</td><td>GALVANİZ</td><td>25 KG</td></tr> <tr><td>FCS-AKS-0480</td><td>55x11x5</td><td>GALVANİZ</td><td>25 KG</td></tr> <tr><td>FCS-AKS-0481</td><td>55x13x5</td><td>GALVANİZ</td><td>25 KG</td></tr> <tr><td>FCS-AKS-0482</td><td>55x11x3</td><td>GALVANİZ</td><td>25 KG</td></tr> <tr><td>FCS-AKS-0483</td><td>55x13x3</td><td>GALVANİZ</td><td>25 KG</td></tr> </tbody> </table> | KOD | ÖLÇÜ | KAPLAMA | PAKET | FCS-AKS-0478 | 55x11x4 | GALVANİZ | 25 KG | FCS-AKS-0479 | 55x13x4 | GALVANİZ | 25 KG | FCS-AKS-0480 | 55x11x5 | GALVANİZ | 25 KG | FCS-AKS-0481 | 55x13x5 | GALVANİZ | 25 KG | FCS-AKS-0482 | 55x11x3 | GALVANİZ | 25 KG | FCS-AKS-0483 | 55x13x3 | GALVANİZ | 25 KG | <table border="1"> <thead> <tr> <th>KOD</th> <th>ÖLÇÜ</th> <th>KAPLAMA</th> <th>PAKET</th> </tr> </thead> <tbody> <tr><td>FCS-AKS-0484</td><td>50x11x4</td><td>GALVANİZ</td><td>25 KG</td></tr> <tr><td>FCS-AKS-0485</td><td>50x13x4</td><td>GALVANİZ</td><td>25 KG</td></tr> <tr><td>FCS-AKS-0486</td><td>50x11x5</td><td>GALVANİZ</td><td>25 KG</td></tr> <tr><td>FCS-AKS-0487</td><td>50x13x5</td><td>GALVANİZ</td><td>25 KG</td></tr> </tbody> </table> | KOD | ÖLÇÜ | KAPLAMA | PAKET | FCS-AKS-0484 | 50x11x4 | GALVANİZ | 25 KG | FCS-AKS-0485 | 50x13x4 | GALVANİZ | 25 KG | FCS-AKS-0486 | 50x11x5 | GALVANİZ | 25 KG | FCS-AKS-0487 | 50x13x5 | GALVANİZ | 25 KG | <table border="1"> <thead> <tr> <th>KOD</th> <th>ÖLÇÜ</th> <th>KAPLAMA</th> <th>PAKET</th> </tr> </thead> <tbody> <tr><td>FCS-AKS-0488</td><td>65x13x4</td><td>GALVANİZ</td><td>25 KG</td></tr> <tr><td>FCS-AKS-0489</td><td>65x13x5</td><td>GALVANİZ</td><td>25 KG</td></tr> </tbody> </table> <p>Dişli Pul</p> <table border="1"> <thead> <tr> <th>KOD</th> <th>ÖLÇÜ</th> <th>KAPLAMA</th> <th>PAKET</th> </tr> </thead> <tbody> <tr><td>FCS-AKS-0490</td><td>M10 DİŞLİ</td><td>GALVANİZ</td><td>500 AD.</td></tr> <tr><td>FCS-AKS-0491</td><td>M10 DİŞLİ</td><td>GALVANİZ</td><td>500 AD.</td></tr> </tbody> </table> | KOD | ÖLÇÜ | KAPLAMA | PAKET | FCS-AKS-0488 | 65x13x4 | GALVANİZ | 25 KG | FCS-AKS-0489 | 65x13x5 | GALVANİZ | 25 KG | KOD | ÖLÇÜ | KAPLAMA | PAKET | FCS-AKS-0490 | M10 DİŞLİ | GALVANİZ | 500 AD. | FCS-AKS-0491 | M10 DİŞLİ | GALVANİZ | 500 AD. | | | | | | | | | | | | | | | | |
| KOD | ÖLÇÜ | KAPLAMA | PAKET | | | | | | | | | | | | | | | | | | | | | | | | | | | | | | | | | | | | | | | | | | | | | | | | | | | | | | | | | | | | | | | | | | | | | | | | | | | | | | | | | | | | | | | |
| FCS-AKS-0478 | 55x11x4 | GALVANİZ | 25 KG | | | | | | | | | | | | | | | | | | | | | | | | | | | | | | | | | | | | | | | | | | | | | | | | | | | | | | | | | | | | | | | | | | | | | | | | | | | | | | | | | | | | | | | |
| FCS-AKS-0479 | 55x13x4 | GALVANİZ | 25 KG | | | | | | | | | | | | | | | | | | | | | | | | | | | | | | | | | | | | | | | | | | | | | | | | | | | | | | | | | | | | | | | | | | | | | | | | | | | | | | | | | | | | | | | |
| FCS-AKS-0480 | 55x11x5 | GALVANİZ | 25 KG | | | | | | | | | | | | | | | | | | | | | | | | | | | | | | | | | | | | | | | | | | | | | | | | | | | | | | | | | | | | | | | | | | | | | | | | | | | | | | | | | | | | | | | |
| FCS-AKS-0481 | 55x13x5 | GALVANİZ | 25 KG | | | | | | | | | | | | | | | | | | | | | | | | | | | | | | | | | | | | | | | | | | | | | | | | | | | | | | | | | | | | | | | | | | | | | | | | | | | | | | | | | | | | | | | |
| FCS-AKS-0482 | 55x11x3 | GALVANİZ | 25 KG | | | | | | | | | | | | | | | | | | | | | | | | | | | | | | | | | | | | | | | | | | | | | | | | | | | | | | | | | | | | | | | | | | | | | | | | | | | | | | | | | | | | | | | |
| FCS-AKS-0483 | 55x13x3 | GALVANİZ | 25 KG | | | | | | | | | | | | | | | | | | | | | | | | | | | | | | | | | | | | | | | | | | | | | | | | | | | | | | | | | | | | | | | | | | | | | | | | | | | | | | | | | | | | | | | |
| KOD | ÖLÇÜ | KAPLAMA | PAKET | | | | | | | | | | | | | | | | | | | | | | | | | | | | | | | | | | | | | | | | | | | | | | | | | | | | | | | | | | | | | | | | | | | | | | | | | | | | | | | | | | | | | | | |
| FCS-AKS-0484 | 50x11x4 | GALVANİZ | 25 KG | | | | | | | | | | | | | | | | | | | | | | | | | | | | | | | | | | | | | | | | | | | | | | | | | | | | | | | | | | | | | | | | | | | | | | | | | | | | | | | | | | | | | | | |
| FCS-AKS-0485 | 50x13x4 | GALVANİZ | 25 KG | | | | | | | | | | | | | | | | | | | | | | | | | | | | | | | | | | | | | | | | | | | | | | | | | | | | | | | | | | | | | | | | | | | | | | | | | | | | | | | | | | | | | | | |
| FCS-AKS-0486 | 50x11x5 | GALVANİZ | 25 KG | | | | | | | | | | | | | | | | | | | | | | | | | | | | | | | | | | | | | | | | | | | | | | | | | | | | | | | | | | | | | | | | | | | | | | | | | | | | | | | | | | | | | | | |
| FCS-AKS-0487 | 50x13x5 | GALVANİZ | 25 KG | | | | | | | | | | | | | | | | | | | | | | | | | | | | | | | | | | | | | | | | | | | | | | | | | | | | | | | | | | | | | | | | | | | | | | | | | | | | | | | | | | | | | | | |
| KOD | ÖLÇÜ | KAPLAMA | PAKET | | | | | | | | | | | | | | | | | | | | | | | | | | | | | | | | | | | | | | | | | | | | | | | | | | | | | | | | | | | | | | | | | | | | | | | | | | | | | | | | | | | | | | | |
| FCS-AKS-0488 | 65x13x4 | GALVANİZ | 25 KG | | | | | | | | | | | | | | | | | | | | | | | | | | | | | | | | | | | | | | | | | | | | | | | | | | | | | | | | | | | | | | | | | | | | | | | | | | | | | | | | | | | | | | | |
| FCS-AKS-0489 | 65x13x5 | GALVANİZ | 25 KG | | | | | | | | | | | | | | | | | | | | | | | | | | | | | | | | | | | | | | | | | | | | | | | | | | | | | | | | | | | | | | | | | | | | | | | | | | | | | | | | | | | | | | | |
| KOD | ÖLÇÜ | KAPLAMA | PAKET | | | | | | | | | | | | | | | | | | | | | | | | | | | | | | | | | | | | | | | | | | | | | | | | | | | | | | | | | | | | | | | | | | | | | | | | | | | | | | | | | | | | | | | |
| FCS-AKS-0490 | M10 DİŞLİ | GALVANİZ | 500 AD. | | | | | | | | | | | | | | | | | | | | | | | | | | | | | | | | | | | | | | | | | | | | | | | | | | | | | | | | | | | | | | | | | | | | | | | | | | | | | | | | | | | | | | | |
| FCS-AKS-0491 | M10 DİŞLİ | GALVANİZ | 500 AD. | | | | | | | | | | | | | | | | | | | | | | | | | | | | | | | | | | | | | | | | | | | | | | | | | | | | | | | | | | | | | | | | | | | | | | | | | | | | | | | | | | | | | | | |
| Dübeller | Dübeller 50'lik Şase Pulu | Dübeller | | | | | | | | | | | | | | | | | | | | | | | | | | | | | | | | | | | | | | | | | | | | | | | | | | | | | | | | | | | | | | | | | | | | | | | | | | | | | | | | | | | | | | | | |
|  |  |  | | | | | | | | | | | | | | | | | | | | | | | | | | | | | | | | | | | | | | | | | | | | | | | | | | | | | | | | | | | | | | | | | | | | | | | | | | | | | | | | | | | | | | | | |
| AĞIR YÜK (S TİPİ) DÜBEL | | KANCALI DÜBEL AÇIK | | | | | | | | | | | | | | | | | | | | | | | | | | | | | | | | | | | | | | | | | | | | | | | | | | | | | | | | | | | | | | | | | | | | | | | | | | | | | | | | | | | | | | | | |
| <table border="1"> <thead> <tr> <th>KOD</th> <th>ÖLÇÜ</th> <th>ÇVL ADET</th> </tr> </thead> <tbody> <tr><td>FCS-AKS-0492</td><td>M6</td><td>200</td></tr> <tr><td>FCS-AKS-0493</td><td>M8</td><td>1400</td></tr> <tr><td>FCS-AKS-0494</td><td>M10</td><td>800</td></tr> <tr><td>FCS-AKS-0495</td><td>M12</td><td>800</td></tr> <tr><td>FCS-AKS-0496</td><td>M16</td><td>200</td></tr> </tbody> </table> | KOD | ÖLÇÜ | ÇVL ADET | FCS-AKS-0492 | M6 | 200 | FCS-AKS-0493 | M8 | 1400 | FCS-AKS-0494 | M10 | 800 | FCS-AKS-0495 | M12 | 800 | FCS-AKS-0496 | M16 | 200 | <table border="1"> <thead> <tr> <th>KOD</th> <th>ÖLÇÜ</th> <th>ÇVL ADET</th> </tr> </thead> <tbody> <tr><td>FCS-AKS-0497</td><td>M6x45</td><td>1500</td></tr> </tbody> </table> | KOD | ÖLÇÜ | ÇVL ADET | FCS-AKS-0497 | M6x45 | 1500 | <table border="1"> <thead> <tr> <th>KOD</th> <th>ÖLÇÜ</th> <th>ÇVL ADET</th> </tr> </thead> <tbody> <tr><td>FCS-AKS-0498</td><td>M6</td><td>500</td></tr> <tr><td>FCS-AKS-0499</td><td>M8</td><td>500</td></tr> <tr><td>FCS-AKS-0500</td><td>M10</td><td>250</td></tr> <tr><td>FCS-AKS-0501</td><td>M12</td><td>200</td></tr> </tbody> </table> | KOD | ÖLÇÜ | ÇVL ADET | FCS-AKS-0498 | M6 | 500 | FCS-AKS-0499 | M8 | 500 | FCS-AKS-0500 | M10 | 250 | FCS-AKS-0501 | M12 | 200 | | | | | | | | | | | | | | | | | | | | | | | | | | | | | | | | | | | | | | | | | | | | | | | | | |
| KOD | ÖLÇÜ | ÇVL ADET | | | | | | | | | | | | | | | | | | | | | | | | | | | | | | | | | | | | | | | | | | | | | | | | | | | | | | | | | | | | | | | | | | | | | | | | | | | | | | | | | | | | | | | | |
| FCS-AKS-0492 | M6 | 200 | | | | | | | | | | | | | | | | | | | | | | | | | | | | | | | | | | | | | | | | | | | | | | | | | | | | | | | | | | | | | | | | | | | | | | | | | | | | | | | | | | | | | | | | |
| FCS-AKS-0493 | M8 | 1400 | | | | | | | | | | | | | | | | | | | | | | | | | | | | | | | | | | | | | | | | | | | | | | | | | | | | | | | | | | | | | | | | | | | | | | | | | | | | | | | | | | | | | | | | |
| FCS-AKS-0494 | M10 | 800 | | | | | | | | | | | | | | | | | | | | | | | | | | | | | | | | | | | | | | | | | | | | | | | | | | | | | | | | | | | | | | | | | | | | | | | | | | | | | | | | | | | | | | | | |
| FCS-AKS-0495 | M12 | 800 | | | | | | | | | | | | | | | | | | | | | | | | | | | | | | | | | | | | | | | | | | | | | | | | | | | | | | | | | | | | | | | | | | | | | | | | | | | | | | | | | | | | | | | | |
| FCS-AKS-0496 | M16 | 200 | | | | | | | | | | | | | | | | | | | | | | | | | | | | | | | | | | | | | | | | | | | | | | | | | | | | | | | | | | | | | | | | | | | | | | | | | | | | | | | | | | | | | | | | |
| KOD | ÖLÇÜ | ÇVL ADET | | | | | | | | | | | | | | | | | | | | | | | | | | | | | | | | | | | | | | | | | | | | | | | | | | | | | | | | | | | | | | | | | | | | | | | | | | | | | | | | | | | | | | | | |
| FCS-AKS-0497 | M6x45 | 1500 | | | | | | | | | | | | | | | | | | | | | | | | | | | | | | | | | | | | | | | | | | | | | | | | | | | | | | | | | | | | | | | | | | | | | | | | | | | | | | | | | | | | | | | | |
| KOD | ÖLÇÜ | ÇVL ADET | | | | | | | | | | | | | | | | | | | | | | | | | | | | | | | | | | | | | | | | | | | | | | | | | | | | | | | | | | | | | | | | | | | | | | | | | | | | | | | | | | | | | | | | |
| FCS-AKS-0498 | M6 | 500 | | | | | | | | | | | | | | | | | | | | | | | | | | | | | | | | | | | | | | | | | | | | | | | | | | | | | | | | | | | | | | | | | | | | | | | | | | | | | | | | | | | | | | | | |
| FCS-AKS-0499 | M8 | 500 | | | | | | | | | | | | | | | | | | | | | | | | | | | | | | | | | | | | | | | | | | | | | | | | | | | | | | | | | | | | | | | | | | | | | | | | | | | | | | | | | | | | | | | | |
| FCS-AKS-0500 | M10 | 250 | | | | | | | | | | | | | | | | | | | | | | | | | | | | | | | | | | | | | | | | | | | | | | | | | | | | | | | | | | | | | | | | | | | | | | | | | | | | | | | | | | | | | | | | |
| FCS-AKS-0501 | M12 | 200 | | | | | | | | | | | | | | | | | | | | | | | | | | | | | | | | | | | | | | | | | | | | | | | | | | | | | | | | | | | | | | | | | | | | | | | | | | | | | | | | | | | | | | | | |

| Dübeller | | | Dübeller | | | Dübeller | | | | | | | | | | | | | | | | | | | | | | | | | | | | | | | | | | | | | | | | | | | | | | | | | | | | | | | | | | | | | | | | | | | | | | | | | | | | | | | | | | | | | | | | | | | | | | | | | | | | | | | | |
|--|---------|----------|----------|------|----------|--------------|-------|------|--------------|-------|-----|--------------|---------|-----|--------------|--------|-----|--------------|---------|-----|--------------|--------|-----|--------------|---------|-----|--------------|---------|-----|--------------|---------|-----|--------------|---------|----|--------------|---------|----|--------------|---------|----|---|--|--|-----|------|----------|--------------|-------|------|--------------|-------|------|--------------|-------|------|--------------|-------|-----|--------------|--------|-----|--------------|--------|-----|--------------|---------|-----|--------------|--------|-----|--------------|--------|-----|--------------|---------|-----|--|--|--|-----|------|----------|--------------|-------|-----|--------------|-------|-----|--------------|--------|-----|--------------|--------|-----|--------------|---------|-----|--------------|---------|-----|--------------|---------|-----|--------------|---------|-----|--------------|---------|----|
|  <p>BORULU ÇELİK DÜBEL</p> <table border="1"> <thead> <tr> <th>KOD</th> <th>ÖLÇÜ</th> <th>ÇVL ADET</th> </tr> </thead> <tbody> <tr><td>FCS-AKS-0502</td><td>M6x65</td><td>1000</td></tr> <tr><td>FCS-AKS-0503</td><td>M8x75</td><td>500</td></tr> <tr><td>FCS-AKS-0504</td><td>M10x110</td><td>500</td></tr> <tr><td>FCS-AKS-0505</td><td>M10x85</td><td>500</td></tr> <tr><td>FCS-AKS-0506</td><td>M10x110</td><td>400</td></tr> <tr><td>FCS-AKS-0507</td><td>M12x90</td><td>250</td></tr> <tr><td>FCS-AKS-0508</td><td>M12x110</td><td>250</td></tr> <tr><td>FCS-AKS-0509</td><td>M14x110</td><td>100</td></tr> <tr><td>FCS-AKS-0510</td><td>M16x120</td><td>100</td></tr> <tr><td>FCS-AKS-0511</td><td>M16x200</td><td>50</td></tr> <tr><td>FCS-AKS-0512</td><td>M20x140</td><td>50</td></tr> <tr><td>FCS-AKS-0513</td><td>M20x170</td><td>50</td></tr> </tbody> </table> | | | KOD | ÖLÇÜ | ÇVL ADET | FCS-AKS-0502 | M6x65 | 1000 | FCS-AKS-0503 | M8x75 | 500 | FCS-AKS-0504 | M10x110 | 500 | FCS-AKS-0505 | M10x85 | 500 | FCS-AKS-0506 | M10x110 | 400 | FCS-AKS-0507 | M12x90 | 250 | FCS-AKS-0508 | M12x110 | 250 | FCS-AKS-0509 | M14x110 | 100 | FCS-AKS-0510 | M16x120 | 100 | FCS-AKS-0511 | M16x200 | 50 | FCS-AKS-0512 | M20x140 | 50 | FCS-AKS-0513 | M20x170 | 50 |  <p>GÖMLEKLİ ÇELİK DÜBEL</p> <table border="1"> <thead> <tr> <th>KOD</th> <th>ÖLÇÜ</th> <th>ÇVL ADET</th> </tr> </thead> <tbody> <tr><td>FCS-AKS-0514</td><td>M6x45</td><td>1500</td></tr> <tr><td>FCS-AKS-0515</td><td>M6x65</td><td>1500</td></tr> <tr><td>FCS-AKS-0516</td><td>M8x55</td><td>1500</td></tr> <tr><td>FCS-AKS-0517</td><td>M8x75</td><td>500</td></tr> <tr><td>FCS-AKS-0518</td><td>M10x70</td><td>400</td></tr> <tr><td>FCS-AKS-0519</td><td>M10x85</td><td>400</td></tr> <tr><td>FCS-AKS-0520</td><td>M10x110</td><td>400</td></tr> <tr><td>FCS-AKS-0521</td><td>M12x75</td><td>250</td></tr> <tr><td>FCS-AKS-0522</td><td>M12x90</td><td>250</td></tr> <tr><td>FCS-AKS-0523</td><td>M12x110</td><td>250</td></tr> </tbody> </table> | | | KOD | ÖLÇÜ | ÇVL ADET | FCS-AKS-0514 | M6x45 | 1500 | FCS-AKS-0515 | M6x65 | 1500 | FCS-AKS-0516 | M8x55 | 1500 | FCS-AKS-0517 | M8x75 | 500 | FCS-AKS-0518 | M10x70 | 400 | FCS-AKS-0519 | M10x85 | 400 | FCS-AKS-0520 | M10x110 | 400 | FCS-AKS-0521 | M12x75 | 250 | FCS-AKS-0522 | M12x90 | 250 | FCS-AKS-0523 | M12x110 | 250 |  <p>CİVATALI (KLİPSLİ) DÜBEL</p> <table border="1"> <thead> <tr> <th>KOD</th> <th>ÖLÇÜ</th> <th>ÇVL ADET</th> </tr> </thead> <tbody> <tr><td>FCS-AKS-0524</td><td>M6x45</td><td>600</td></tr> <tr><td>FCS-AKS-0525</td><td>M8x75</td><td>600</td></tr> <tr><td>FCS-AKS-0526</td><td>M10x90</td><td>250</td></tr> <tr><td>FCS-AKS-0527</td><td>M12x90</td><td>250</td></tr> <tr><td>FCS-AKS-0528</td><td>M12x110</td><td>240</td></tr> <tr><td>FCS-AKS-0529</td><td>M16x110</td><td>100</td></tr> <tr><td>FCS-AKS-0530</td><td>M16x145</td><td>100</td></tr> <tr><td>FCS-AKS-0531</td><td>M18x150</td><td>100</td></tr> <tr><td>FCS-AKS-0532</td><td>M20x180</td><td>40</td></tr> </tbody> </table> | | | KOD | ÖLÇÜ | ÇVL ADET | FCS-AKS-0524 | M6x45 | 600 | FCS-AKS-0525 | M8x75 | 600 | FCS-AKS-0526 | M10x90 | 250 | FCS-AKS-0527 | M12x90 | 250 | FCS-AKS-0528 | M12x110 | 240 | FCS-AKS-0529 | M16x110 | 100 | FCS-AKS-0530 | M16x145 | 100 | FCS-AKS-0531 | M18x150 | 100 | FCS-AKS-0532 | M20x180 | 40 |
| KOD | ÖLÇÜ | ÇVL ADET | | | | | | | | | | | | | | | | | | | | | | | | | | | | | | | | | | | | | | | | | | | | | | | | | | | | | | | | | | | | | | | | | | | | | | | | | | | | | | | | | | | | | | | | | | | | | | | | | | | | | | | | | | | | |
| FCS-AKS-0502 | M6x65 | 1000 | | | | | | | | | | | | | | | | | | | | | | | | | | | | | | | | | | | | | | | | | | | | | | | | | | | | | | | | | | | | | | | | | | | | | | | | | | | | | | | | | | | | | | | | | | | | | | | | | | | | | | | | | | | | |
| FCS-AKS-0503 | M8x75 | 500 | | | | | | | | | | | | | | | | | | | | | | | | | | | | | | | | | | | | | | | | | | | | | | | | | | | | | | | | | | | | | | | | | | | | | | | | | | | | | | | | | | | | | | | | | | | | | | | | | | | | | | | | | | | | |
| FCS-AKS-0504 | M10x110 | 500 | | | | | | | | | | | | | | | | | | | | | | | | | | | | | | | | | | | | | | | | | | | | | | | | | | | | | | | | | | | | | | | | | | | | | | | | | | | | | | | | | | | | | | | | | | | | | | | | | | | | | | | | | | | | |
| FCS-AKS-0505 | M10x85 | 500 | | | | | | | | | | | | | | | | | | | | | | | | | | | | | | | | | | | | | | | | | | | | | | | | | | | | | | | | | | | | | | | | | | | | | | | | | | | | | | | | | | | | | | | | | | | | | | | | | | | | | | | | | | | | |
| FCS-AKS-0506 | M10x110 | 400 | | | | | | | | | | | | | | | | | | | | | | | | | | | | | | | | | | | | | | | | | | | | | | | | | | | | | | | | | | | | | | | | | | | | | | | | | | | | | | | | | | | | | | | | | | | | | | | | | | | | | | | | | | | | |
| FCS-AKS-0507 | M12x90 | 250 | | | | | | | | | | | | | | | | | | | | | | | | | | | | | | | | | | | | | | | | | | | | | | | | | | | | | | | | | | | | | | | | | | | | | | | | | | | | | | | | | | | | | | | | | | | | | | | | | | | | | | | | | | | | |
| FCS-AKS-0508 | M12x110 | 250 | | | | | | | | | | | | | | | | | | | | | | | | | | | | | | | | | | | | | | | | | | | | | | | | | | | | | | | | | | | | | | | | | | | | | | | | | | | | | | | | | | | | | | | | | | | | | | | | | | | | | | | | | | | | |
| FCS-AKS-0509 | M14x110 | 100 | | | | | | | | | | | | | | | | | | | | | | | | | | | | | | | | | | | | | | | | | | | | | | | | | | | | | | | | | | | | | | | | | | | | | | | | | | | | | | | | | | | | | | | | | | | | | | | | | | | | | | | | | | | | |
| FCS-AKS-0510 | M16x120 | 100 | | | | | | | | | | | | | | | | | | | | | | | | | | | | | | | | | | | | | | | | | | | | | | | | | | | | | | | | | | | | | | | | | | | | | | | | | | | | | | | | | | | | | | | | | | | | | | | | | | | | | | | | | | | | |
| FCS-AKS-0511 | M16x200 | 50 | | | | | | | | | | | | | | | | | | | | | | | | | | | | | | | | | | | | | | | | | | | | | | | | | | | | | | | | | | | | | | | | | | | | | | | | | | | | | | | | | | | | | | | | | | | | | | | | | | | | | | | | | | | | |
| FCS-AKS-0512 | M20x140 | 50 | | | | | | | | | | | | | | | | | | | | | | | | | | | | | | | | | | | | | | | | | | | | | | | | | | | | | | | | | | | | | | | | | | | | | | | | | | | | | | | | | | | | | | | | | | | | | | | | | | | | | | | | | | | | |
| FCS-AKS-0513 | M20x170 | 50 | | | | | | | | | | | | | | | | | | | | | | | | | | | | | | | | | | | | | | | | | | | | | | | | | | | | | | | | | | | | | | | | | | | | | | | | | | | | | | | | | | | | | | | | | | | | | | | | | | | | | | | | | | | | |
| KOD | ÖLÇÜ | ÇVL ADET | | | | | | | | | | | | | | | | | | | | | | | | | | | | | | | | | | | | | | | | | | | | | | | | | | | | | | | | | | | | | | | | | | | | | | | | | | | | | | | | | | | | | | | | | | | | | | | | | | | | | | | | | | | | |
| FCS-AKS-0514 | M6x45 | 1500 | | | | | | | | | | | | | | | | | | | | | | | | | | | | | | | | | | | | | | | | | | | | | | | | | | | | | | | | | | | | | | | | | | | | | | | | | | | | | | | | | | | | | | | | | | | | | | | | | | | | | | | | | | | | |
| FCS-AKS-0515 | M6x65 | 1500 | | | | | | | | | | | | | | | | | | | | | | | | | | | | | | | | | | | | | | | | | | | | | | | | | | | | | | | | | | | | | | | | | | | | | | | | | | | | | | | | | | | | | | | | | | | | | | | | | | | | | | | | | | | | |
| FCS-AKS-0516 | M8x55 | 1500 | | | | | | | | | | | | | | | | | | | | | | | | | | | | | | | | | | | | | | | | | | | | | | | | | | | | | | | | | | | | | | | | | | | | | | | | | | | | | | | | | | | | | | | | | | | | | | | | | | | | | | | | | | | | |
| FCS-AKS-0517 | M8x75 | 500 | | | | | | | | | | | | | | | | | | | | | | | | | | | | | | | | | | | | | | | | | | | | | | | | | | | | | | | | | | | | | | | | | | | | | | | | | | | | | | | | | | | | | | | | | | | | | | | | | | | | | | | | | | | | |
| FCS-AKS-0518 | M10x70 | 400 | | | | | | | | | | | | | | | | | | | | | | | | | | | | | | | | | | | | | | | | | | | | | | | | | | | | | | | | | | | | | | | | | | | | | | | | | | | | | | | | | | | | | | | | | | | | | | | | | | | | | | | | | | | | |
| FCS-AKS-0519 | M10x85 | 400 | | | | | | | | | | | | | | | | | | | | | | | | | | | | | | | | | | | | | | | | | | | | | | | | | | | | | | | | | | | | | | | | | | | | | | | | | | | | | | | | | | | | | | | | | | | | | | | | | | | | | | | | | | | | |
| FCS-AKS-0520 | M10x110 | 400 | | | | | | | | | | | | | | | | | | | | | | | | | | | | | | | | | | | | | | | | | | | | | | | | | | | | | | | | | | | | | | | | | | | | | | | | | | | | | | | | | | | | | | | | | | | | | | | | | | | | | | | | | | | | |
| FCS-AKS-0521 | M12x75 | 250 | | | | | | | | | | | | | | | | | | | | | | | | | | | | | | | | | | | | | | | | | | | | | | | | | | | | | | | | | | | | | | | | | | | | | | | | | | | | | | | | | | | | | | | | | | | | | | | | | | | | | | | | | | | | |
| FCS-AKS-0522 | M12x90 | 250 | | | | | | | | | | | | | | | | | | | | | | | | | | | | | | | | | | | | | | | | | | | | | | | | | | | | | | | | | | | | | | | | | | | | | | | | | | | | | | | | | | | | | | | | | | | | | | | | | | | | | | | | | | | | |
| FCS-AKS-0523 | M12x110 | 250 | | | | | | | | | | | | | | | | | | | | | | | | | | | | | | | | | | | | | | | | | | | | | | | | | | | | | | | | | | | | | | | | | | | | | | | | | | | | | | | | | | | | | | | | | | | | | | | | | | | | | | | | | | | | |
| KOD | ÖLÇÜ | ÇVL ADET | | | | | | | | | | | | | | | | | | | | | | | | | | | | | | | | | | | | | | | | | | | | | | | | | | | | | | | | | | | | | | | | | | | | | | | | | | | | | | | | | | | | | | | | | | | | | | | | | | | | | | | | | | | | |
| FCS-AKS-0524 | M6x45 | 600 | | | | | | | | | | | | | | | | | | | | | | | | | | | | | | | | | | | | | | | | | | | | | | | | | | | | | | | | | | | | | | | | | | | | | | | | | | | | | | | | | | | | | | | | | | | | | | | | | | | | | | | | | | | | |
| FCS-AKS-0525 | M8x75 | 600 | | | | | | | | | | | | | | | | | | | | | | | | | | | | | | | | | | | | | | | | | | | | | | | | | | | | | | | | | | | | | | | | | | | | | | | | | | | | | | | | | | | | | | | | | | | | | | | | | | | | | | | | | | | | |
| FCS-AKS-0526 | M10x90 | 250 | | | | | | | | | | | | | | | | | | | | | | | | | | | | | | | | | | | | | | | | | | | | | | | | | | | | | | | | | | | | | | | | | | | | | | | | | | | | | | | | | | | | | | | | | | | | | | | | | | | | | | | | | | | | |
| FCS-AKS-0527 | M12x90 | 250 | | | | | | | | | | | | | | | | | | | | | | | | | | | | | | | | | | | | | | | | | | | | | | | | | | | | | | | | | | | | | | | | | | | | | | | | | | | | | | | | | | | | | | | | | | | | | | | | | | | | | | | | | | | | |
| FCS-AKS-0528 | M12x110 | 240 | | | | | | | | | | | | | | | | | | | | | | | | | | | | | | | | | | | | | | | | | | | | | | | | | | | | | | | | | | | | | | | | | | | | | | | | | | | | | | | | | | | | | | | | | | | | | | | | | | | | | | | | | | | | |
| FCS-AKS-0529 | M16x110 | 100 | | | | | | | | | | | | | | | | | | | | | | | | | | | | | | | | | | | | | | | | | | | | | | | | | | | | | | | | | | | | | | | | | | | | | | | | | | | | | | | | | | | | | | | | | | | | | | | | | | | | | | | | | | | | |
| FCS-AKS-0530 | M16x145 | 100 | | | | | | | | | | | | | | | | | | | | | | | | | | | | | | | | | | | | | | | | | | | | | | | | | | | | | | | | | | | | | | | | | | | | | | | | | | | | | | | | | | | | | | | | | | | | | | | | | | | | | | | | | | | | |
| FCS-AKS-0531 | M18x150 | 100 | | | | | | | | | | | | | | | | | | | | | | | | | | | | | | | | | | | | | | | | | | | | | | | | | | | | | | | | | | | | | | | | | | | | | | | | | | | | | | | | | | | | | | | | | | | | | | | | | | | | | | | | | | | | |
| FCS-AKS-0532 | M20x180 | 40 | | | | | | | | | | | | | | | | | | | | | | | | | | | | | | | | | | | | | | | | | | | | | | | | | | | | | | | | | | | | | | | | | | | | | | | | | | | | | | | | | | | | | | | | | | | | | | | | | | | | | | | | | | | | |

| Dübeller | | | Dübeller | | | FCS-AKS-0545 Eldivenler | | | | | | | | | | | | | | | | | | | | | | | | | | | | | | | | | | | | | | | | | | | |
|--|------|----------|----------|------|----------|-------------------------|----|-----|--------------|----|-----|--------------|-----|-----|--------------|-----|-----|--|--|--|-----|------|----------|--------------|----|------|--------------|----|------|--------------|-----|------|--------------|-----|-----|--------------|-----|-----|--------------|-----|-----|--------------|-----|-----|--------------|-----|-----|---|--|
|  <p>KANCALI DÜBEL KAPALI</p> <table border="1"> <thead> <tr> <th>KOD</th> <th>ÖLÇÜ</th> <th>ÇVL ADET</th> </tr> </thead> <tbody> <tr><td>FCS-AKS-0533</td><td>M6</td><td>500</td></tr> <tr><td>FCS-AKS-0534</td><td>M8</td><td>500</td></tr> <tr><td>FCS-AKS-0535</td><td>M10</td><td>250</td></tr> <tr><td>FCS-AKS-0536</td><td>M12</td><td>200</td></tr> </tbody> </table> | | | KOD | ÖLÇÜ | ÇVL ADET | FCS-AKS-0533 | M6 | 500 | FCS-AKS-0534 | M8 | 500 | FCS-AKS-0535 | M10 | 250 | FCS-AKS-0536 | M12 | 200 |  <p>ÇAKMA DÜBEL</p> <table border="1"> <thead> <tr> <th>KOD</th> <th>ÖLÇÜ</th> <th>ÇVL ADET</th> </tr> </thead> <tbody> <tr><td>FCS-AKS-0537</td><td>M6</td><td>2000</td></tr> <tr><td>FCS-AKS-0538</td><td>M8</td><td>2000</td></tr> <tr><td>FCS-AKS-0539</td><td>M10</td><td>1000</td></tr> <tr><td>FCS-AKS-0540</td><td>M12</td><td>500</td></tr> <tr><td>FCS-AKS-0541</td><td>M14</td><td>250</td></tr> <tr><td>FCS-AKS-0542</td><td>M16</td><td>200</td></tr> <tr><td>FCS-AKS-0543</td><td>M18</td><td>150</td></tr> <tr><td>FCS-AKS-0544</td><td>M20</td><td>100</td></tr> </tbody> </table> | | | KOD | ÖLÇÜ | ÇVL ADET | FCS-AKS-0537 | M6 | 2000 | FCS-AKS-0538 | M8 | 2000 | FCS-AKS-0539 | M10 | 1000 | FCS-AKS-0540 | M12 | 500 | FCS-AKS-0541 | M14 | 250 | FCS-AKS-0542 | M16 | 200 | FCS-AKS-0543 | M18 | 150 | FCS-AKS-0544 | M20 | 100 |  <p>FCS-AKS-0545 Nitril Eldiven</p>  <p>FCS-AKS-0546 Argon Eldiven</p>  <p>FCS-AKS-0547 Asit Eldiveni</p>  <p>FCS-AKS-0548 Kaynakçı Eldiveni</p>  <p>FCS-AKS-0549 Montaj Eldiveni</p>  <p>FCS-AKS-0550 Argon Eldiven</p> | |
| KOD | ÖLÇÜ | ÇVL ADET | | | | | | | | | | | | | | | | | | | | | | | | | | | | | | | | | | | | | | | | | | | | | | | |
| FCS-AKS-0533 | M6 | 500 | | | | | | | | | | | | | | | | | | | | | | | | | | | | | | | | | | | | | | | | | | | | | | | |
| FCS-AKS-0534 | M8 | 500 | | | | | | | | | | | | | | | | | | | | | | | | | | | | | | | | | | | | | | | | | | | | | | | |
| FCS-AKS-0535 | M10 | 250 | | | | | | | | | | | | | | | | | | | | | | | | | | | | | | | | | | | | | | | | | | | | | | | |
| FCS-AKS-0536 | M12 | 200 | | | | | | | | | | | | | | | | | | | | | | | | | | | | | | | | | | | | | | | | | | | | | | | |
| KOD | ÖLÇÜ | ÇVL ADET | | | | | | | | | | | | | | | | | | | | | | | | | | | | | | | | | | | | | | | | | | | | | | | |
| FCS-AKS-0537 | M6 | 2000 | | | | | | | | | | | | | | | | | | | | | | | | | | | | | | | | | | | | | | | | | | | | | | | |
| FCS-AKS-0538 | M8 | 2000 | | | | | | | | | | | | | | | | | | | | | | | | | | | | | | | | | | | | | | | | | | | | | | | |
| FCS-AKS-0539 | M10 | 1000 | | | | | | | | | | | | | | | | | | | | | | | | | | | | | | | | | | | | | | | | | | | | | | | |
| FCS-AKS-0540 | M12 | 500 | | | | | | | | | | | | | | | | | | | | | | | | | | | | | | | | | | | | | | | | | | | | | | | |
| FCS-AKS-0541 | M14 | 250 | | | | | | | | | | | | | | | | | | | | | | | | | | | | | | | | | | | | | | | | | | | | | | | |
| FCS-AKS-0542 | M16 | 200 | | | | | | | | | | | | | | | | | | | | | | | | | | | | | | | | | | | | | | | | | | | | | | | |
| FCS-AKS-0543 | M18 | 150 | | | | | | | | | | | | | | | | | | | | | | | | | | | | | | | | | | | | | | | | | | | | | | | |
| FCS-AKS-0544 | M20 | 100 | | | | | | | | | | | | | | | | | | | | | | | | | | | | | | | | | | | | | | | | | | | | | | | |

Matkap Uçları ve Vidalar

YILDIZ HAVŞA BAŞLI MATKAP UÇLU VİDA

| KOD | ÖLÇÜ | YHB MUV |
|-------------|-----------|---------|
| FCS-VD-0001 | 3,9 x 13 | YHB MUV |
| FCS-VD-0002 | 3,9 x 16 | YHB MUV |
| FCS-VD-0003 | 3,9 x 19 | YHB MUV |
| FCS-VD-0004 | 3,9 x 22 | YHB MUV |
| FCS-VD-0005 | 3,9 x 25 | YHB MUV |
| FCS-VD-0006 | 3,9 x 28 | YHB MUV |
| FCS-VD-0007 | 3,9 x 32 | YHB MUV |
| FCS-VD-0008 | 3,9 x 38 | YHB MUV |
| FCS-VD-0009 | 4,2 x 13 | YHB MUV |
| FCS-VD-0010 | 4,2 x 16 | YHB MUV |
| FCS-VD-0011 | 4,2 x 19 | YHB MUV |
| FCS-VD-0012 | 4,2 x 22 | YHB MUV |
| FCS-VD-0013 | 4,2 x 25 | YHB MUV |
| FCS-VD-0014 | 4,2 x 32 | YHB MUV |
| FCS-VD-0015 | 4,2 x 38 | YHB MUV |
| FCS-VD-0016 | 4,2 x 45 | YHB MUV |
| FCS-VD-0017 | 4,2 x 50 | YHB MUV |
| FCS-VD-0018 | 4,8 x 16 | YHB MUV |
| FCS-VD-0019 | 4,8 x 19 | YHB MUV |
| FCS-VD-0020 | 4,8 x 22 | YHB MUV |
| FCS-VD-0021 | 4,8 x 25 | YHB MUV |
| FCS-VD-0022 | 4,8 x 32 | YHB MUV |
| FCS-VD-0023 | 4,8 x 38 | YHB MUV |
| FCS-VD-0024 | 4,8 x 45 | YHB MUV |
| FCS-VD-0025 | 4,8 x 50 | YHB MUV |
| FCS-VD-0026 | 4,8 x 60 | YHB MUV |
| FCS-VD-0027 | 4,8 x 70 | YHB MUV |
| FCS-VD-0028 | 4,8 x 80 | YHB MUV |
| FCS-VD-0029 | 4,8 x 100 | YHB MUV |

BORAZAN MATKAP UÇLU VİDA

| KOD | ÖLÇÜ | ALC MUV |
|-------------|----------|---------|
| FCS-VD-0030 | 3,5 x 25 | ALC MUV |
| FCS-VD-0031 | 3,5 x 35 | ALC MUV |
| FCS-VD-0032 | 3,5 x 45 | ALC MUV |

BORAZAN SİVRİ UÇLU VİDA

| KOD | ÖLÇÜ | ALC SIV |
|-------------|----------|---------|
| FCS-VD-0033 | 3,5 x 25 | ALC SIV |
| FCS-VD-0034 | 3,5 x 35 | ALC SIV |
| FCS-VD-0035 | 3,5 x 45 | ALC SIV |



Matkap Uçları ve Vidalar

YILDIZ HAVŞA BAŞLI MATKAP UÇLU VİDA

| KOD | ÖLÇÜ | YSB MUV |
|-------------|------------|---------|
| FCS-VD-0036 | 3,5 x 10,5 | YSB MUV |
| FCS-VD-0037 | 3,9 x 9,5 | YSB MUV |
| FCS-VD-0038 | 3,9 x 13 | YSB MUV |
| FCS-VD-0039 | 3,9 x 16 | YSB MUV |
| FCS-VD-0040 | 3,9 x 19 | YSB MUV |
| FCS-VD-0041 | 3,9 x 22 | YSB MUV |
| FCS-VD-0042 | 3,9 x 25 | YSB MUV |
| FCS-VD-0043 | 3,9 x 32 | YSB MUV |
| FCS-VD-0044 | 3,9 x 38 | YSB MUV |
| FCS-VD-0045 | 4,2 x 13 | YSB MUV |
| FCS-VD-0046 | 4,2 x 16 | YSB MUV |
| FCS-VD-0047 | 4,2 x 19 | YSB MUV |
| FCS-VD-0048 | 4,2 x 22 | YSB MUV |
| FCS-VD-0049 | 4,2 x 25 | YSB MUV |
| FCS-VD-0050 | 4,2 x 32 | YSB MUV |
| FCS-VD-0051 | 4,2 x 38 | YSB MUV |
| FCS-VD-0052 | 4,2 x 45 | YSB MUV |
| FCS-VD-0053 | 4,2 x 50 | YSB MUV |
| FCS-VD-0054 | 4,8 x 13 | YSB MUV |
| FCS-VD-0055 | 4,8 x 16 | YSB MUV |
| FCS-VD-0056 | 4,8 x 19 | YSB MUV |
| FCS-VD-0057 | 4,8 x 22 | YSB MUV |
| FCS-VD-0058 | 4,8 x 25 | YSB MUV |
| FCS-VD-0059 | 4,8 x 32 | YSB MUV |
| FCS-VD-0060 | 4,8 x 38 | YSB MUV |
| FCS-VD-0061 | 4,8 x 45 | YSB MUV |
| FCS-VD-0062 | 4,8 x 50 | YSB MUV |
| FCS-VD-0063 | 4,8 x 60 | YSB MUV |
| FCS-VD-0064 | 4,8 x 70 | YSB MUV |
| FCS-VD-0065 | 4,8 x 80 | YSB MUV |
| FCS-VD-0066 | 4,8 x 100 | YSB MUV |

BORAZAN MATKAP UÇLU VİDA

| KOD | ÖLÇÜ | OVL MUV |
|-------------|----------|---------|
| FCS-VD-0067 | 3,9 x 16 | OVL MUV |
| FCS-VD-0068 | 3,9 x 19 | OVL MUV |
| FCS-VD-0069 | 3,9 x 25 | OVL MUV |

BORAZAN SIVRİ UÇLU VİDA

| KOD | ÖLÇÜ | YFB MUV |
|-------------|----------|---------|
| FCS-VD-0070 | 3,9 x 13 | YFB MUV |
| FCS-VD-0071 | 3,9 x 16 | YFB MUV |
| FCS-VD-0072 | 3,9 x 19 | YFB MUV |
| FCS-VD-0073 | 3,9 x 25 | YFB MUV |
| FCS-VD-0074 | 4,2 x 16 | YFB MUV |
| FCS-VD-0075 | 4,2 x 19 | YFB MUV |



Matkap Uçları ve Vidalar

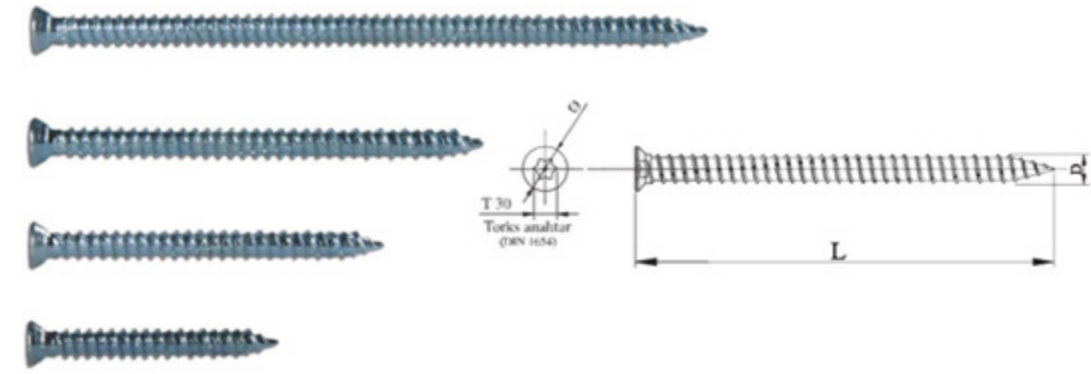



















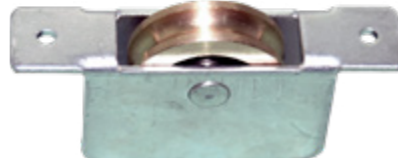





DÜBELSİZ MONTAJ VİDALARI

| KOD | ÖLÇÜ | TDR MON |
|-------------|------------------|---------|
| FCS-VD-0076 | 7,5 x 60 | TDR MON |
| FCS-VD-0077 | 7,5 x 80 | TDR MON |
| FCS-VD-0078 | 7,5 x 100 | TDR MON |
| FCS-VD-0079 | 7,5 x 120 | TDR MON |
| FCS-VD-0080 | 7,5 x 150 | TDR MON |
| FCS-VD-0081 | 7,5 x 180 | TDR MON |
| FCS-VD-0082 | 7,5 x 200 | TDR MON |
| FCS-VD-0083 | VİDA BAŞI KAPAĞI | |

VİDALAMA UÇLARI

| KOD | ÖLÇÜ | VİD UCU |
|-------------|-----------|---------|
| FCS-VD-0084 | PH2 x 25 | VİD UCU |
| FCS-VD-0085 | PH2 x 50 | VİD UCU |
| FCS-VD-0086 | PH3 x 25 | VİD UCU |
| FCS-VD-0087 | PH3 x 50 | VİD UCU |
| FCS-VD-0088 | PZ 1 x 50 | VİD UCU |
| FCS-VD-0089 | PZ 2 x 25 | VİD UCU |
| FCS-VD-0090 | PZ 2 x 50 | VİD UCU |
| FCS-VD-0091 | PZ 3 x 25 | VİD UCU |
| FCS-VD-0092 | PZ 3 x 50 | VİD UCU |
| FCS-VD-0093 | T 30 x 25 | TDR UCU |
| FCS-VD-0094 | T 30 x 50 | TDR UCU |

| | | |
|---|---|---|
| FCS-AKS-0551 70"lik Tuba Rulman (Pirinç) | FCS-AKS-0552 70"lik Tuba Rulman (Plastik) | FCS-AKS-0553 100"lük Tuba Rulman(Pirinç) |
|  |  |  |
| 200 Koli içi adet | 200 Koli içi adet | 250 Koli içi adet |
| FCS-AKS-0554 100"lük Tuba Rulman(Plastik) | FCS-AKS-0555 Alu.Tekli Tuba Rulman (Pirinç) | FCS-AKS-0556 Alu.Tekli Tuba Rulman (Plastik) |
|  |  |  |
| 250 Koli içi adet | 300 Koli içi adet | 300 Koli içi adet |
| FCS-AKS-0557 Alu.Çiftli Tuba Rulman (Pirinç) | FCS-AKS-0558 Alu.Çiftli Tuba Rulman (Plastik) | FCS-AKS-0559 100"lük Polyemit Rulman |
|  |  |  |
| 150 Koli içi adet | 150 Koli içi adet | 150 Koli içi adet |
| FCS-AKS-0560 67"lik Çiftli Rulman | FCS-AKS-0561 100"lük İnce Sürme Rulman | FCS-AKS-0562 67"lik Sürme Polyemit Rulman |
|  |  |  |
| 150 Koli içi adet | 150 Koli içi adet | 150 Koli içi adet |

| | | |
|---|---|---|
| FCS-AKS-0563 Sineklik Rulman | FCS-AKS-0564 67"lik Sürme Polyemit Rulman | FCS-AKS-0565 100"lük Sürme İnce Polyemit Rulman |
|  |  |  |
| 200 Koli içi adet | 200 Koli içi adet | 250 Koli içi adet |
| FCS-AKS-0566 10 cm Ayak Tutucu | FCS-AKS-0567 15 cm Ayak Tutucu | FCS-AKS-0568 Kabin Sürgü |
|  |  |  |
| 120 Koli içi adet | 120 Koli içi adet | 75 Koli içi adet |
| FCS-AKS-0569 Yaprak Mentеше | FCS-AKS-0570 Duvar L Bağlantı | FCS-AKS-0571 Kabin Kapı Topuzu |
|  |  |  |
| 100 Koli içi adet | 500 Koli içi adet | 200 Koli içi adet |
| FCS-AKS-0572 U Bağlantı | FCS-AKS-0573 Kapı Askısı | FCS-AKS-0574 Yaylı Emniyet Kiliti |
|  |  |  |
| 100 Koli içi adet | 500 Koli içi adet | 250 Koli içi adet |

| ÜRÜN KODU | MALZEME ADI | ÖLÇÜLERİ | KOLİ İÇİ RULO | RULO/mt | KOLİ/mt |
|-------------|-------------|-----------|---------------|---------|---------|
| FCS-KF-0001 | KIL FİTİL | 48-450 | 4 | 550 | 2200 |
| FCS-KF-0002 | KIL FİTİL | 48-500 | 4 | 550 | 2200 |
| FCS-KF-0003 | KIL FİTİL | 48-550 | 4 | 500 | 2000 |
| FCS-KF-0004 | KIL FİTİL | 48-650 | 4 | 450 | 1800 |
| FCS-KF-0005 | KIL FİTİL | 48-800 | 4 | 275 | 1100 |
| FCS-KF-0006 | KIL FİTİL | 48-1000 | 4 | 250 | 1000 |
| FCS-KF-0007 | KIL FİTİL | 48-1200 | 4 | 200 | 800 |
| FCS-KF-0008 | KIL FİTİL | 51-650 | 4 | 350 | 1400 |
| FCS-KF-0009 | KIL FİTİL | 51-800 | 4 | 325 | 1200 |
| FCS-KF-0010 | KIL FİTİL | 55-650 | 4 | 350 | 1400 |
| FCS-KF-0011 | KIL FİTİL | 55-700 | 4 | 350 | 1400 |
| FCS-KF-0012 | KIL FİTİL | 60-575 | 4 | 350 | 1400 |
| FCS-KF-0013 | KIL FİTİL | 67-500 | 4 | 375 | 1500 |
| FCS-KF-0014 | KIL FİTİL | 67-550 | 4 | 375 | 1500 |
| FCS-KF-0015 | KIL FİTİL | 67-600 | 4 | 350 | 1400 |
| FCS-KF-0016 | KIL FİTİL | 67-650 | 4 | 350 | 1400 |
| FCS-KF-0017 | KIL FİTİL | 67-700 | 4 | 300 | 1200 |
| FCS-KF-0018 | KIL FİTİL | 67-800 | 4 | 250 | 1000 |
| FCS-KF-0019 | KIL FİTİL | 67-900 | 4 | 225 | 900 |
| FCS-KF-0020 | KIL FİTİL | 67-1000 | 4 | 200 | 800 |
| FCS-KF-0021 | KIL FİTİL | 67-1200 | 4 | 175 | 700 |
| FCS-KF-0022 | KIL FİTİL | 67-1500 | 4 | 125 | 500 |
| FCS-KF-0023 | KIL FİTİL | 67-1800 | 4 | 100 | 400 |
| FCS-KF-0024 | KIL FİTİL | 67-2000 | 4 | 100 | 400 |
| FCS-KF-0025 | KIL FİTİL | 69-700 | 4 | 250 | 1000 |
| FCS-KF-0026 | KIL FİTİL | 69-1000 | 4 | 200 | 800 |
| FCS-KF-0027 | KIL FİTİL | 72-800 | 4 | 200 | 800 |
| FCS-KF-0028 | KIL FİTİL | 127-700 | 4 | 175 | 700 |
| FCS-KF-0029 | KIL FİTİL | 48-500 F | 2 | 700 | 1400 |
| FCS-KF-0030 | KIL FİTİL | 48-800 F | 2 | 450 | 900 |
| FCS-KF-0031 | KIL FİTİL | 48-1000 F | 2 | 350 | 700 |
| FCS-KF-0032 | KIL FİTİL | 48-1200 F | 2 | 300 | 600 |
| FCS-KF-0033 | KIL FİTİL | 51-650 F | 2 | 650 | 1300 |
| FCS-KF-0034 | KIL FİTİL | 51-800 F | 2 | 600 | 1200 |
| FCS-KF-0035 | KIL FİTİL | 55-650 F | 2 | 650 | 1300 |
| FCS-KF-0036 | KIL FİTİL | 55-700 F | 2 | 650 | 1300 |
| FCS-KF-0037 | KIL FİTİL | 60-575 F | 2 | 600 | 1200 |
| FCS-KF-0038 | KIL FİTİL | 67-700 F | 2 | 500 | 1000 |
| FCS-KF-0039 | KIL FİTİL | 67-1000 F | 2 | 350 | 700 |
| FCS-KF-0040 | KIL FİTİL | 67-1200 F | 2 | 300 | 600 |
| FCS-KF-0041 | KIL FİTİL | 68-700 F | 2 | 500 | 1000 |
| FCS-KF-0042 | KIL FİTİL | 69-700 F | 2 | 450 | 900 |
| FCS-KF-0043 | KIL FİTİL | 69-800 F | 2 | 425 | 850 |
| FCS-KF-0044 | KIL FİTİL | 69-1000 F | 2 | 350 | 700 |
| FCS-KF-0045 | KIL FİTİL | 72-800 F | 2 | 350 | 700 |
| FCS-KF-0046 | KIL FİTİL | 127-700 F | 2 | 300 | 600 |



| ÜRÜN PROFİLİ | ÜRÜN ADI | ÜRÜN KODU | BİRİM ÖLÇÜ | PAKET MİK. | ÜRÜN PROFİLİ | ÜRÜN ADI | ÜRÜN KODU | BİRİM ÖLÇÜ | PAKET MİK. |
|--------------|-----------------|-------------|------------|------------|--------------|-------------------------------|-------------|------------|------------|
| | Kasa Conta | FCS-CN-0001 | 28 gr/m | 100 m | | Cam Contası | FCS-CN-0010 | 46 gr/m | 12 Kg |
| | Kanat Contası | FCS-CN-0002 | 48 gr/m | 100 m | | Üniversal Conta | FCS-CN-0011 | 48 gr/m | 12 Kg |
| | 4mm Cam Contası | FCS-CN-0003 | 71 gr/m | 100 m | | Yarı Cam Contası | FCS-CN-0012 | 47 gr/m | 12 Kg |
| | Hortum Conta | FCS-CN-0004 | 59 gr/m | 100 m | | 200 mm Cam Kasa Kanat Contası | FCS-CN-0013 | 62 gr/m | 10 Kg |
| | Çıta Contası | FCS-CN-0005 | 62 gr/m | 12 Kg | | Kasa Kanat Contası | FCS-CN-0014 | 42 gr/m | 10 Kg |
| | Çıta Çantası | FCS-CN-0006 | 74 gr/m | 12 Kg | | 20 mm Cam Contası | FCS-CN-0015 | 50 gr/m | 12 Kg |
| | Çıta Contası | FCS-CN-0007 | 63 gr/m | 12 Kg | | Polikarbon Fiti | FCS-CN-0016 | 52 gr/m | 12 Kg |
| | Saplama Contası | FCS-CN-0008 | 45 gr/m | 12 Kg | | Çıta Contası | FCS-CN-0017 | 98 gr/m | 12 Kg |
| | Saplama Contası | FCS-CN-0009 | 62 gr/m | 12 Kg | | Cam Contası | FCS-CN-0018 | 55 gr/m | 12 Kg |



İzalsasyon Grubu (Silikon Çeşitleri)

FCS-SL-0001 / MSP 2720
MS Polimer Hibrid Mastik



- ÖZELLİKLER**
- Su geçirmezdir ve hava nemle birlikte elastik ve esnek bir özelliğe kavuşur.
 - Hava koşullarından ve genleşme hareketlerinden etkilenmez.
 - Solvent, silikon içermez ve kokusuzdur.
 - Çok iyi UV dayanıklılığı vardır.
 - Tek komponentlidir.
 - Üzeri boyanabilir.
 - Kabarcık oluşumu yoktur.
 - Çok düşük büzülme.
 - Mükemmel elastikiyet ve çok iyi yapışma gücü.
 - Solvent, silikon ve izosiyanat içermez.
 - Yangına dayanıklıdır, DIN 4102-1'e göre B2 sınıfı



FCS-SL-0002 / MSP 2730
MS Polimer Hibrid Mastik



- ÖZELLİKLER**
- Su geçirmezdir, hava nemle birlikte elastik ve esnek bir özelliğe kavuşur.
 - Çözücü maddelerden arındırılmış ve kokusuzdur.
 - Çok iyi UV dayanıklılığı vardır.
 - Tek komponentlidir.
 - Üzeri boyanabilir.
 - Kabarcık oluşumu yoktur.
 - Çok düşük büzülme.
 - Mükemmel elastikiyet ve çok iyi yapışma gücü.
 - Solvent, silikon ve PCB içermez.



FCS-SL-0003 / SuperGrip 5075
Astar

Bostik SuperGrip 5075, MS Polimer esaslı, mastik tarzındaki sızdıFCSzlık maddelerinin, emici ve gözenekli alt yüzeylere (beton, sıva vb) daha iyi yapışması ve mukavemet değerlerinin artması için formüle edilmiş özel bir üründür.



- ÖZELLİKLER**
- Sarfıyatı azaltır.
 - Mukavemeti artırır.

FCS-SL-0004 / WeatherSeal
Cephe Silikonu



- ÖZELLİKLER**
- Kullanıma hazır, tek bileşenli bir sızdıFCSzlık malzemesidir.
 - Solvent içermez.
 - Elastikiyetini sürekli korur.
 - Yaşlanmaya, hava şartlarına ve UV ışınlarına dayanıklıdır.
 - Uygulamadan (+20°C'de) yaklaşık 1 saat sonra hava şartlarından etkilenmez.
 - Kuruyan yüzeylere başka malzemeler yapışmaz.
 - Boya tutmaz.



FCS-SL-0005 / Construction
Nötral Cephe Silikonu

- ÖZELLİKLER**
- Kullanıma hazır, tek bileşenli bir sızdıFCSzlık malzemesidir.
 - Solvent içermez.
 - Elastikiyetini sürekli korur.
 - Uygulamadan (+20°C'de) yaklaşık 1 saat sonra hava şartlarından etkilenmez.
 - Kuruyan yüzeylere başka malzemeler yapışmaz.
 - Boya tutmaz.
 - Deterjanlı suya ve seyreltik asitlere dayanıklıdır.



FCS-SL-0006 / Universal
Genel Amaçlı 100% Saf Silikon



- ÖZELLİKLER**
- Kullanıma hazır, tek bileşenli bir sızdıFCSzlık malzemesidir.
 - Solvent içermez.
 - 100% silikondur.
 - Çatlama, hacim kaybına uğramaz.
 - Elastikiyetini sürekli korur.
 - Yaşlanmaya, hava şartlarına ve UV ışınlarına dayanıklıdır.
 - Aşınmaya dayanıklıdır.
 - Uygulamadan (+20°C'de) yaklaşık 1 saat sonra hava şartlarından etkilenmez.
 - Kuruyan yüzeylere başka malzemeler yapışmaz.
 - Üzeri boya tutmaz.
 - Sertleşmenin tamamlanması ile elde edilen elastik malzeme 40°C ile +180°C arasındaki ısı farklarından etkilenmez.



FCS-SL-0007 / ForeverSaniter
Hijyenik Silikon



- ÖZELLİKLER**
- Uzun süreli rengini muhafaza eder.
 - SaraFCS yapmaz.
 - Solvent içermez.
 - Çatlama, hacim kaybına uğramaz.
 - 100% silikondur.
 - Elastikiyetini sürekli korur.
 - Yaşlanmaya, hava şartlarına ve UV ışınlarına dayanıklıdır.
 - Aşınmaya dayanıklıdır.
 - Uygulamadan (+20°C'de) yaklaşık 1 saat sonra hava şartlarından etkilenmez.
 - Kuruyan yüzeylere başka malzemeler yapışmaz.
 - Üzeri boya tutmaz.
 - Sertleşmenin tamamlanması ile elde edilen elastik malzeme 40°C ile +180°C arasındaki ısı farklarından etkilenmez.
 - EN 1561-3'e göre mikroorganizma gelişim perfoFCSnsı XS2 sınıfındadır.



FCS-SL-0008
Çekomastik 801



- ÖZELLİKLER**
- Kullanıma hazır, tek bileşenli bir sızdıFCSzlık malzemesidir.
 - Hafif asetat kokusu kuruduktan sonra kaybolur.
 - Elastikiyetini sürekli korur.
 - Yaşlanmaya, hava şartlarına ve UV ışınlarına dayanıklıdır.
 - Aşınmaya dayanıklıdır.
 - Uygulamadan (+20°C'de) yaklaşık 1 saat sonra hava şartlarından etkilenmez.
 - Kuruyan yüzeylere başka malzemeler yapışmaz.
 - Üzeri boya tutmaz.
 - Deterjanlı suya ve seyreltik asitlere dayanıklıdır.
 - Oda sıcaklığında ve kısa süreli temaslarda aseto, eter, toluen, alkol, benzol, benzin, fuel-oil, DOP, amonyak, sirke,%20 sodalı su, vb. etkilenmez. Uzun süreli temasta şişme yaparsa da, kuruyunca eski haline döner



FCS-SL-0009
Çekomastik 803
Isıya Dayanıklı Silikon



- ÖZELLİKLER**
- Kullanıma hazır, tek bileşenli bir sızdıFCSzlık malzemesidir.
 - 300°C sıcaklığa dayanıklı bir malzemedir.
 - Hafif asetat kokusu kuruduktan sonra kaybolur.
 - Solvent içermez.
 - Elastikiyetini sürekli korur.
 - Aşınmaya dayanıklıdır.
 - Uygulamadan (+20°C'de) yaklaşık 1 saat sonra hava şartlarından etkilenmez.
 - Kuruyan yüzeylere başka malzemeler yapışmaz.
 - Boya tutmaz.



FCS-SL-0010
Çekomastik 803
Oto Sıvı Conta



- ÖZELLİKLER**
- Kullanıma hazır, tek bileşenli bir sızdıFCSzlık malzemesidir.
 - Çekomastik 803 Oto Sıvı Conta sıcaklığa dayanıklı bir malzemedir.
 - Hafif asetat kokusu kuruduktan sonra kaybolur.
 - Solvent içermez.
 - Aşınmaya dayanıklıdır.
 - Uygulamadan (+20°C'de) yaklaşık 1 saat sonra hava şartlarından etkilenmez.
 - Kuruyan yüzeylere başka malzemeler yapışmaz.
 - Boya tutmaz.



FCS-SL-0011
Çekomastik 805



- ÖZELLİKLER**
- Kullanıma hazır, tek bileşenli bir sızdıFCSzlık malzemesidir.
 - Başka silikon çeşitlerinin, mermer ve doğal taşlarda zaman içinde leke yapma ihtimaline karşı, Çekomastik 805 Mermer Silikonunda bu sakınca yoktur.
 - Solvent içermez.
 - Elastikiyetini sürekli korur.
 - Yaşlanmaya, hava şartlarına ve UV ışınlarına dayanıklıdır.
 - Uygulamadan (+20°C'de) yaklaşık 1 saat sonra hava şartlarından etkilenmez.
 - Kuruyan yüzeylere başka malzemeler yapışmaz.
 - Boya tutmaz.
 - Deterjanlı suya ve seyreltik asitlere dayanıklıdır.



FCS-SL-0012
Çekomastik 806
Sıvı Conta



ÜRÜN TANIMI

Çekomastik 806 Sıvı Conta, polisiloksan esaslı, hava ile sertleşen, asetat sistem bir sızdıFCSzlık malzemesidir.

- ÖZELLİKLER**
- Elastikiyetini sürekli korur.
 - Yaşlanmaya, hava şartlarına ve UV ışınlarına dayanıklıdır.
 - Uygulamadan (+20°C'de) yak. 1 saat sonra hava şartlarından etkilenmez.
 - Kuruyan yüzeyler başka malzemelere yapışmaz.
 - Boya tutmaz.
 - Deterjanlı suya ve seyreltik asitlere dayanıklıdır.



FCS-SL-0013 / Çekomastik 888
Üniversal Silikon



ÖZELLİKLER

- Kullanıma hazır, tek bileşenli bir sızdıFCSzlık malzemesidir.
- Hafif asetat kokusu kuruduktan sonra kaybolur.
- Elastikiyetini sürekli korur.
- Yaşlanmaya, hava şartlarına ve UV ışınlarına dayanıklıdır.
- Aşınmaya dayanıklıdır.
- Boya tutmaz.
- Deterjanlı suya ve seyreltik asitlere dayanıklıdır.

FCS-SL-0014 / ButylSeal
Butil Mastik



ÖZELLİKLER

- Bostik ButylSeal, özelliklerini uzun süre korur, titreşimle dökülmez.
- Sacı koruyucu ve pas önleyici kimyasal maddeler içerir.
- Doldurulduğu boşluklara nem ve toz girmesini önler.
- Yaşlanmaya, hava şartlarına ve UV ışınlarına dayanıklıdır.

FCS-SL-0015 / Black 450
Butil Kauçuk Macun



ÖZELLİKLER

- İyi yapıştıFCS özelliği yüzeye bağlantıyı sağlar.
- Kolay şekillendirilir.
- Uygulaması kolay ve temizdir.
- Dayanıklı, kalıcı, sağlam, esnek yapışma sağlar.
- Kokusuzdur.
- Çok çeşit malzemeyi yapıştırır.
- Suyu dayanıklı.
- Değişik formlarda ve ebatlarda bulunabilir.

FCS-SL-0016
Çekomastik 018
Butil Sıvı Macun



ÖZELLİKLER

- Çekomastik 018 Butil Macun özelliklerini uzun süre korur (titreşimle dökülmez).
- Sacı koruyucu ve pas önleyici kimyasal maddeler içerir.
- Doldurulduğu boşluklara nem ve toz girmesini önler.
- Yaşlanmaya, ortam şartlarına ve UV'ye dayanıklıdır.

FCS-SL-0017
Çekomastik 666
Montaj Mastiği



ÖZELLİKLER

- Kullanıma hazır, tek bileşenli bir sızdıFCSzlık malzemesidir.
- Kuruduktan sonra boyanabilir.
- Elastikiyetini sürekli korur.
- Dış kabuğu zedelenmeyen darbelere ve aşınmaya dayanıklıdır.
- -20°C ila +70°C sıcaklıklarda uzun yıllar özelliklerini korur.

FCS-SL-0018
Çekomastik 677
Silikonize Akrilik Mastik



ÖZELLİKLER

- Kullanıma hazır, tek bileşenli bir sızdıFCSzlık malzemesidir.
- Kuruduktan sonra boyanabilir.
- Elastikiyetini sürekli korur.
- Yaşlanmaya ve UV ışınlarına dayanıklıdır.
- Dış kabuğu zedelenmeyen darbelere ve aşınmaya dayanıklıdır.
- -20°C ila +70°C sıcaklıklarda uzun yıllar özelliklerini korur.

FCS-SL-0019 / PU Seal
Poliüretan Mastik



ÖZELLİKLER

- Kullanıma hazır, tek bileşenli bir sızdıFCSzlık malzemesidir.
- Kabarcıksız kürlenir.
- ISO 11600 F25 LM gerekliliklerini karşılar.
- Hacim kaybı olmaksızın uzun yıllar elastikiyetini korur.
- Sarkma yapmaz, yaşlanmaya ve aşınmaya dayanıklıdır.
- Sıcaklık değişimlerinden(-40°C ile +180°C) ve birçok kimyasal maddeden(seyreltik) etkilenmez.

FCS-SL-0021 / PuFoam
Adaptörlü PU Köpük



ÖZELLİKLER

- Mükemmel yapışma ve dolgu özelliği ile yüksek teFCSI ve akustik izolasyon değeri.
- Ozon tabakasına zarar verebilecek herhangi bir itici gaz içermez.
- Küf tutmaz, su geçirmez ve üzeri boyanabilir.
- Neme ve sıcaklığa bağlı olmak üzere 45 litreye kadar verim ve %30'a kadar genleşme.
- Tabancalı uygulama sayesinde ekonomik kullanım.
- DIN 4102-1 no'lu standarta göre B3 sınıfa girer.

FCS-SL-0023
Çekomastik 760



ÖZELLİKLER

- Mükemmel yapışma ve dolgu özelliği ile yüksek teFCSI ve akustik izolasyon değeri.
- Mükemmel montaj özelliği ve stabilite.
- Hemen hemen tüm inşaat malzemelerine yapışabilir(polietilen, teflon, silikon, yağlar vb. hariç).
- Küf tutmaz, su geçirmez ve üzeri boyanabilir.
- Kuruduktan sonra sertleşen köpük kesilebilir, zımparalanabilir, boyanabilir ve üzeri sıvanabilir.
- Ozon tabakasına zarar verebilecek herhangi bir itici gaz içermez.

FCS-SL-0020 / InsuFoam
Mantolama Köpüğü



ÖZELLİKLER

- Mükemmel yapışma ve dolgu özelliği ile yüksek ısı yalıtımı sağlar.
- Kullanımı kolaydır.
- Kullanıma hazırdır.
- Kokusuzdur.
- Hızlı kurur.(2 saat sonra dübelleme yapma imkanı sağlar)
- Ozon tabakasına zarar verebilecek herhangi bir itici gaz içermez.
- Küf tutmaz, su geçirmez ve üzeri boyanabilir.
- Tabancalı uygulama sayesinde ekonomik kullanım.

FCS-SL-0022 / GunFoam
Tabancalı PU Köpük



ÖZELLİKLER

- Mükemmel yapışma ve dolgu özelliği ile yüksek teFCSI ve akustik izolasyon değeri.
- Ozon tabakasına zarar verebilecek herhangi bir itici gaz içermez.
- Küf tutmaz, su geçirmez ve üzeri boyanabilir.
- Neme ve sıcaklığa bağlı olmak üzere 45 litreye kadar verim ve %30'a kadar genleşme.
- Tabancalı uygulama sayesinde ekonomik kullanım.
- DIN 4102-1 no'lu standarta göre B3 sınıfa girer.

FCS-SL-0024 / RemoFoam
PU Köpük Temizleyicisi



ÖZELLİKLER

- Özellikle GunFoam'ı temizlemek için tasarlanmıştır.
- PU köpüğü, tabancanın adaptöründen temizlemek için sprey valfi bulunur.
- Ozon tabakasına zarar verebilecek herhangi bir itici gaz içermez.

-SL-0025 / FireSeal
Yangına Dayanıklı Silikon Mastik



ÖZELLİKLER

- Isıya dayanıklı silikon.
- Üst düzey yangın sertifikası.
- 4 saate kadar yangına dayanıklılık göstermek için BS 476: Bölüm:20 1987'ye göre onaylanmıştır.
- Kalabalık yerlerde kullanım için daha güvenli bir mastiktir.
- 25 yıla kadar servis ömrü vardır.
- Birçok yüzeye mükemmel yapışma sağlar.
- Mükemmel soğuk duman yalıtımı sağlar.
- İçeride ve dışarıda kullanılabilir.

FCS-SL-0026 / Intucrylic
Yangına Dayanıklı Akrilik Mastik



ÖZELLİKLER

- Su bazlı akrilik mastik
- Üst düzey yangın sertifikası.
- Uygun yapılarda 4 saate kadar yangına dayanıklılık göstermek için BS 476: Bölüm:20 1987'ye göre onaylanmıştır.
- Yüksek sıcaklıklarda bir bariyer oluşturacak şekilde genişler.
- ±%12.5 derz hareket uyumu.
- 30mm genişliğe kadar olan derzlerde çökme yapmaz.
- Minimum büzülme gösterir.
- Birçok yüzeye mükemmel yapışma sağlar.
- Genellikle 15 dakikadan daha az sürede kuru yüzey oluşturur
- Üzeri boyanabilir.

FCS-SL-0027
FR Expanding Foam
Yangına Dayanıklı PU Köpük (B1)



ÖZELLİKLER

- Yangına 4 saate kadar dayanıklılık.
- Duman geçişini önlemek için hava geçirimsiz conta görevi görür.
- Büyük ya da küçük boşlukları doldurur ve yalıtımını sağlar.
- Tek komponentli, hızlı kürlenene poliüretan köpüktür.
- İçeride ve dışarıda kullanılabilir.
- Çoğu inşaat materyaline mükemmel yapışma sağlar.
- Kürlenmiş köpük su geçirmezdir ve kesilebilir, zımparalanabilir ve boyanabilir.
- Polietilen, teflo, silikon ve diğer benzer maddeler üzerinde kullanmayınız.
- Bitüm veya diğer solvenle hassas yüzeylere uygulamayınız.

FCS-SL-0028 / Intustrip
Yangına Dayanıklı Butil Bant



ÖZELLİKLER

- Uygun yapılarda 4 saate kadar yangına dayanıklılık göstermek için BS 476: Bölüm:20 1987'ye göre onaylanmıştır.
- Standart genişlik ve uzunlukta hazır olarak temin edilir.
- Kullanımı kolaydır.
- Ahşaba, metale ve cama mükemmel yapışma sağlar.
- Sıkıştırılmış FCS contalarında ölçüsü sabittir.
- İç kullanım içindir.

FCS-SL-0029 / PSG - H

Polisülfid Dolgu
Yatay Uygulamalar İçin



ÖZELLİKLER

- İki bileşenli, solventsiz bir sızdıFCSzlık malzemesidir.
- Akışkan kimyasallara (jet yakıt, teknik yağ, akaryakıt, biodizel yakıt, inceltilmiş anorganik asit ve çözeltilere) ve tuza karşı dirençlidir.
- Yaşlanmaya hava şartlarına ve UV ışınlarına dayanıklıdır.
- Uygulamadan yaklaşık 24 saat sonra hava şartlarından etkilenmez. (20°C'de).

FCS-SL-0030 / PSG - T

Polisülfid Dolgu
Dikey Uygulamalar İçin



ÖZELLİKLER

- İki bileşenli, solventsiz bir sızdıFCSzlık malzemesidir.
- Tikotropiktir, düşeyde akma yapmaz.
- Kimyasallara (jet yakıt, teknik yağ, akaryakıt, biodizel yakıt, inceltilmiş anorganik asit ve çözeltilere) ve tuza karşı dirençlidir.
- Yaşlanmaya hava şartlarına ve UV ışınlarına dayanıklıdır.
- Uygulamadan yaklaşık 24 saat sonra hava şartlarından etkilenmez. (20°C'de).

FCS-SL-0031 / PSG - PP
Polisülfid Dolgu Emici Yüzey Astarı



ÖZELLİKLER

- Kimyasallara dayanıklıdır.
- Tek komponentlidir.
- Şeffaftır.
- Açık sarı renktedir.
- Visközitesi düşüktür.

FCS-SL-0032 / PSG - MP
Polisülfid Dolgu Emici Olmayan Yüzey Astarı



ÖZELLİKLER

- Tek komponentlidir.
- Şeffaf ve koyu sarı renktedir.
- Su geçirmez ve sızdıFCSz.
- +5°C'nin üzerinde çalışmalıdır.

FCS-SL-0033 / PE Körkasa Bandı
3,00 mm x 40 mm - 3,00 mm x 50 mm

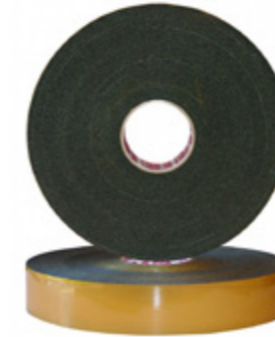

ÜRÜN TANITIMI

Ses ve ısı köprüsü oluşumunu engellemek, tozu ve titreşimi azaltmak, iyi bir sızdıFCSzlık ve ısı yalıtım sağlamak amacıyla kullanılan, UV dayanımlı, kapalı hücreli, tek taraflı yapışkanlı, poliüretan sızdıFCSzlık banttir.

FCS-SL-0034
Çift Taraflı Köpük Bandı
1,00 mm x 20 mm - 1,00 mm x 25 mm



ÜRÜN TANITIMI

Her tür montaj kolaylığı sağlamak amacıyla ilk yapıtıFCSyı sağlamak amacıyla kullanılan, çok hızlı ve güçlü ilk tutunma, yapışma sağlayan çift taraflı yapışkanlı köpük banttir.

FCS-SL-0035
Alüminyum Folyolu Butil Bant
1,00 mm x 50 mm - 1,00 mm x 75 mm



ÜRÜN TANITIMI

Yüksek perfoFCSzslı, esnek, kendinden yapışkanlı, astarsız olarak kolaylıkla kullanılabilen, uygulandığı yüzeyde leke bırakmayan üzeri alüminyum folyo kaplı butil banttir.

FCS-SL-0036
Hofmann PE
Kimyasal Dübel 410 gr



FCS-SL-0037 / Simson MSR CA

Simson MSR Deck Caulk Advanced Silil Modifiye Polimer (SMP) teknolojisine dayanan ve özellikle denizcilik uygulamaları için geliştirilmiş birinci sınıf, tek komponentli, hızlı kürlenene bir marin dolgu ve izolasyon mastiğidir.



ÖZELLİKLER

- Yüksek kimyasal direnç; temizlik ürünlerinden yıpranmaz.
- UV'ye, tatl ve tuzlu suya çok iyi direnç; kullanım süresince dayanıklı sızdıFCSzlik perfoFCSnsı
- Geniş bir sıcaklık aralığında daimi olarak elastik; tüm iklim koşullarında verimlilik



FCS-SL-0038 / MSP 2750 MS Polimer Hibrid Yapıştırıcı



ÖZELLİKLER

- Su geçirmezdir, hava nemle birlikte elastik bir özelliğe kavuşur.
- Çözücü maddelerden arındırılmış ve kokusuzdur.
- Üzeri boyanabilir.
- Kabarcık oluşumu yoktur.
- Çok düşük çekme.
- Elastikiyet ve çok iyi yapışma gücü vardır.
- Solvent, silikon ve izosiyanat içermez.
- Suya karşı dayanıklıdır.
- Astar gerektirmez. (Numune uygulaması gerekir)
- Gıda taşıma araçları ve gıda işleme tesislerinde kullanıma uygunluk belgesi vardır.



FCS-SL-0039 / Wood Fix Ahşap Yapıştırıcı FCS Kiti



ÖZELLİKLER

- Yüksek yapışma gücü.
- Dikey yüzeylerde kullanıma uygun; akma ve sıçrama yapmaz.
- Yüksek viskoziteli olduğu için özellikle gözenekli, yapıştırılması zor yüzeylerde,
- yapışma gücünün artmasını sağlar.

FCS-SL-0040 / MSP SuperTrans Ms Polimer Şeffaf Hibrid Yapıştırıcı



ÖZELLİKLER

- Solvent, silikon ve PCB içermez.
- Kokusuz.
- Kalıcı olarak elastiktir.
- İç ve dış mekan kullanımına uygun.
- Astar gerektirmez. (Numune uygulaması gerekir)
- Şeffaftır.



FCS-SL-0041 Mebran

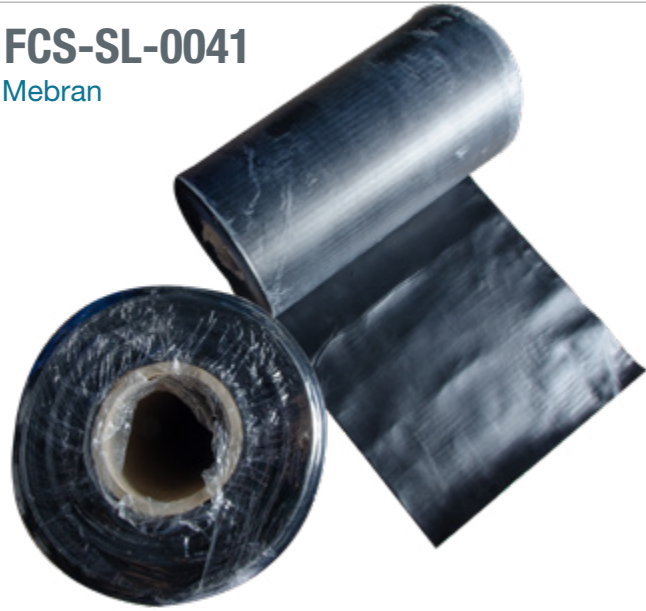

FCS-SL-0042 Fıtıl





www.focusyapisistemleri.com
info@focusyapisistemleri.com

Kızılırmak Mah. Dumlupınar Blv.
Nextlevel No: 3A/10 Çankaya/ANKARA